

Gabriela by Fibre ⚡ood

Gabriela by Fibre ood



Bias tape version



Lined version



XS - XXXL

Gabriela's a sweetheart. This short, loose bodywarmer invites you to play with patterns, colour blocking, stripes in different directions... Let your imagination run wild. With or without a lining, finished with bias tape, tie fastenings, or slanted pockets. Go your own way. It's lovely over a dress as well as over a jumper with trousers or a skirt. An easy-to-make must-have!

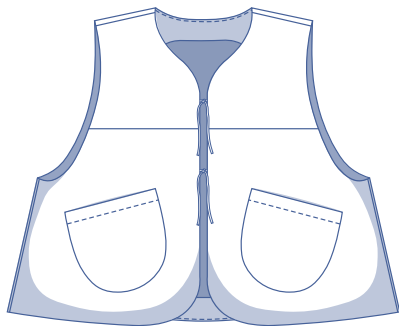

Lined version

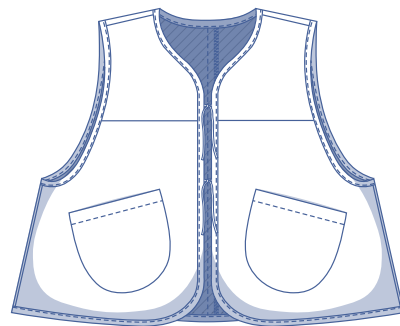

Bias tape version

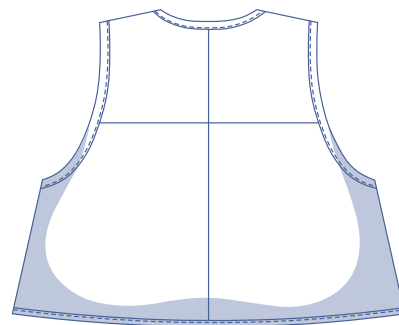
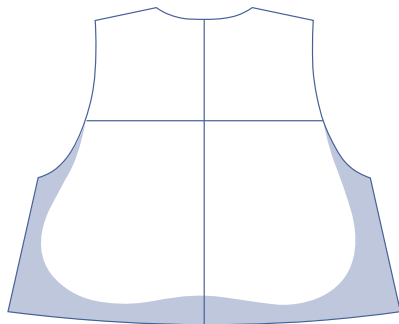

size chart (in cm)

size	XS		S		M		L		XL		XXL		XXXL		
	4	6	8	10	12	14	16	18	20	22	24	26	28	30	32
body height	160	164	166	167	168	169	170	171	172	172	172	172	172	172	172
B (bust)	76	80	84	88	92	96	100	104	110	116	122	128	134	140	146

Choose your size based on the bust measurement. Pick the size that is the best match for your bust.

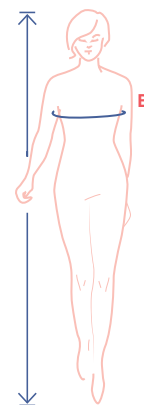

pattern measurements (in cm)

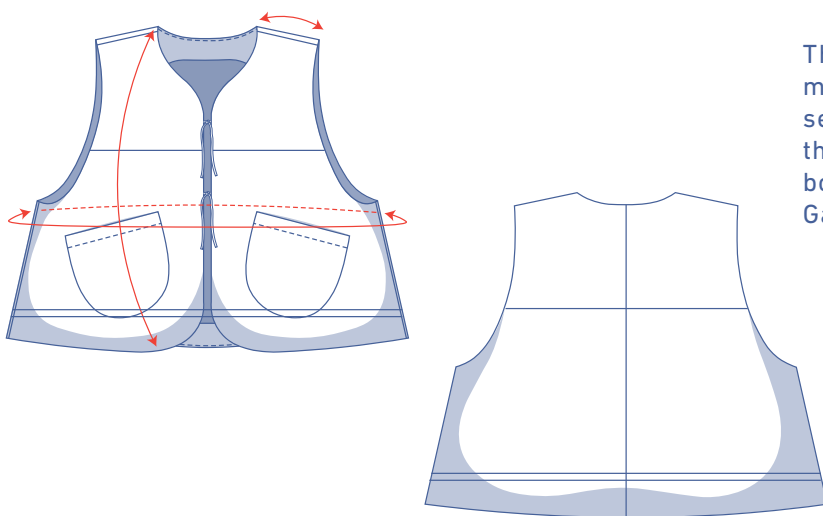

This chart's measurements are the pattern measurements based on the fabric type and serve as a reference. Ease has been added to the width measurements (in addition to the exact body measurements) for a more comfortable fit. Gabriela is designed to have a loose cut.

== shorten or lengthen the pattern here

size	XS	S	M	L	XL	XXL	XXXL
length	53	54.75	56.5	58.25	63.25	65.5	67.75
shoulder length	8.75	9.5	10	10.75	11.25	12	12.5
bust	99.5	107.5	115.5	123.5	133.5	145.5	157.5

Compare the stated lengths to the measured or desired lengths. Lengthen or shorten the bodywarmer by cutting the pattern pieces at the indicated double lines. Then either increase the distance between the cut pieces by the desired amount (to lengthen) or overlap the pieces (to shorten). Make sure that the CF and CB lines and the side seams are always straight.

IMPORTANT

Adjust the amount of fabric to be used based on these alterations.

notions



- Thread
- Iron-on interfacing: max. 100 cm (only for the lined version)
- Bias tape (1.8 cm wide): see table (only for the version with bias tape/no lining)
- Lining: see table (only for the lined version)
- Fabric: see table

bias tape	XS	S	M	L	XL	XXL	XXXL
length per armhole	57.5	61	64	67	71.5	76	80.5
length contour	236	248	261	273	298	316	334
total (in cm)	351	370	389	407	441	468	495

fabric use bias tape version		XS	S	M	L	XL	XXL	XXXL
fabric width 110 cm	cm	85	90	95	105	125	135	140
fabric width 140 cm	cm	65	75	75	85	100	110	115

The corresponding fabric layout can be found starting on page 7 of these sewing instructions.

lining		XS	S	M	L	XL	XXL	XXXL
fabric width 110 cm	cm	55	60	65	75	90	95	100
fabric width 140 cm	cm	50	50	50	55	65	70	85

The corresponding fabric layout can be found starting on page 10 of these sewing instructions.

fabric use lined version		XS	S	M	L	XL	XXL	XXXL
fabric width 110 cm	cm	135	140	160	165	185	205	220
fabric width 140 cm	cm	100	100	110	120	135	165	170

The corresponding fabric layout can be found starting on page 9 of these sewing instructions.

fabric advice



Perfect for Gabriela: padded and quilted fabrics. Also among her favourites: corduroy, double gauze, and woollen fabrics.

Proud to be
#Sewista







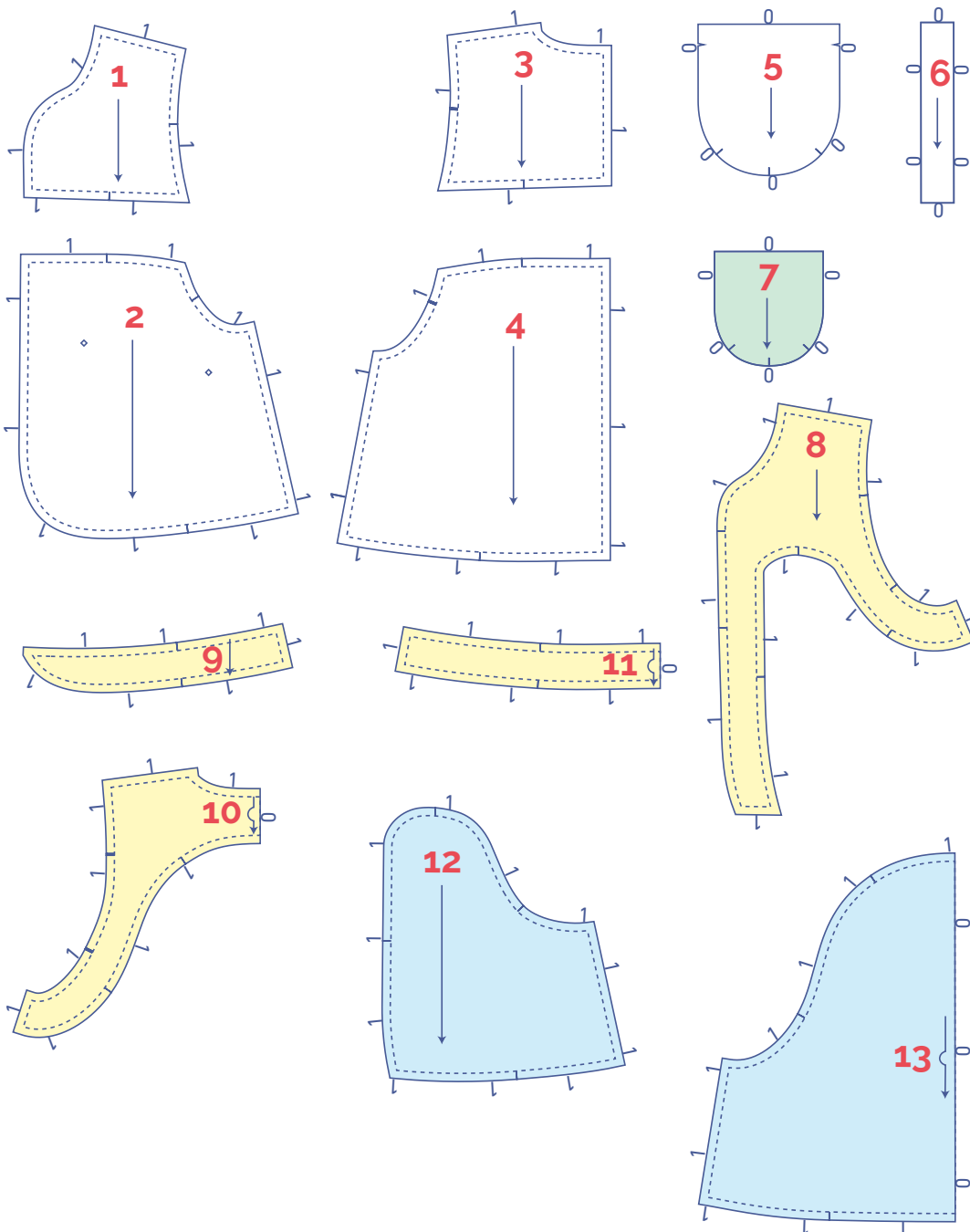

pattern pieces & seam allowances (in cm)

To sew the garment as described in the instructions, draw the illustrated seam allowances around the paper pattern pieces before cutting them out. If you are using a PDF pattern, the pattern can be printed with or without seam allowances. Watch the [video](#) to find out more.

lined version

1. bodice front: 2x
2. bottom piece front: 2x
3. bodice back: 2x
4. bottom piece back: 2x
5. pocket: 2x
6. tie: 4x
7. template for drawing the pocket
8. facing front: 2x
9. hem facing front: 2x
10. facing back: 1x on fabric fold
11. hem facing back: 1x on fabric fold
12. lining front: 2x
13. lining back: 1x on fabric fold





 material type
 fabric
 iron-on interfacing
 lining
 cardboard

bias tape version

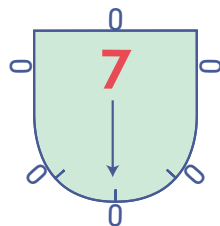
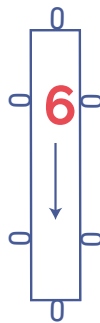
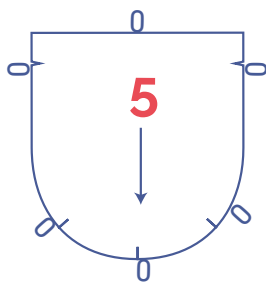
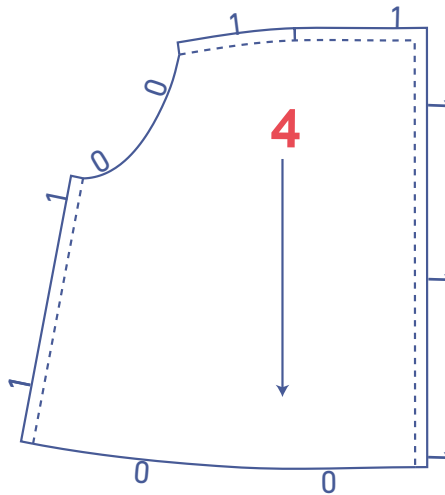
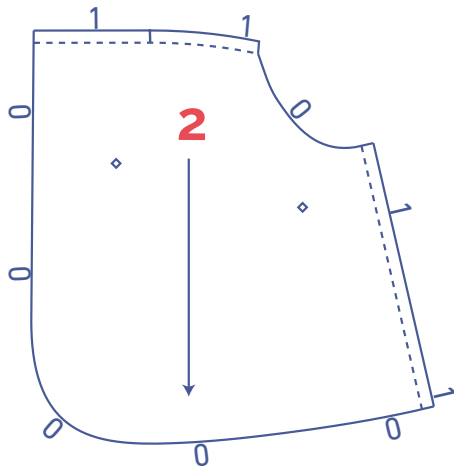
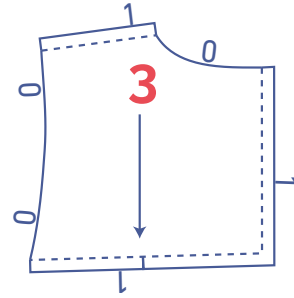
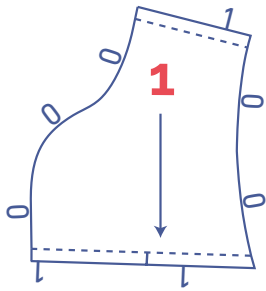
1. top piece front: 2x
2. bottom piece front: 2x
3. top piece back: 2x
4. bottom piece back: 2x
5. pocket: 2x
6. tie: 4x
7. template for drawing the pocket



 material type
 fabric
 cardboard

bias tape version

fabric layout for solid fabrics
fabric width 110 cm

XS - XL

XXL - XXXL

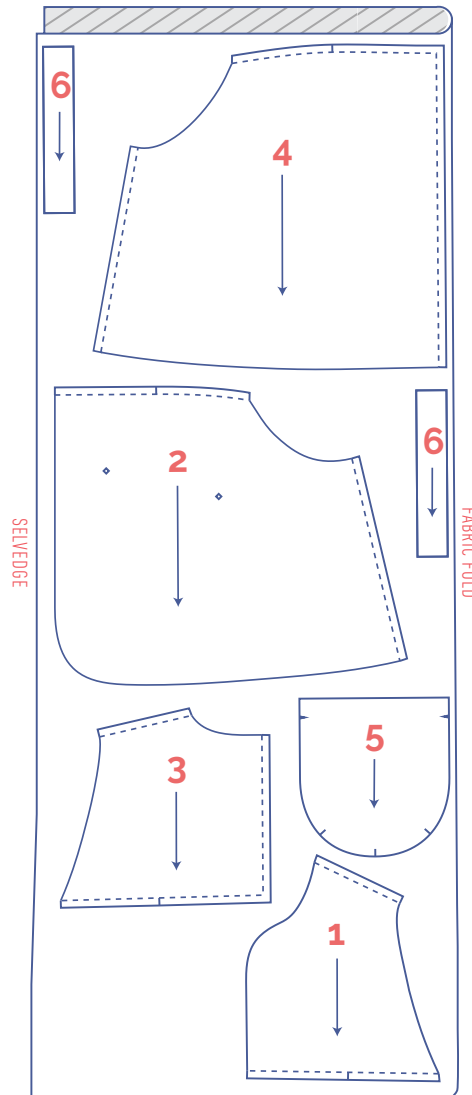
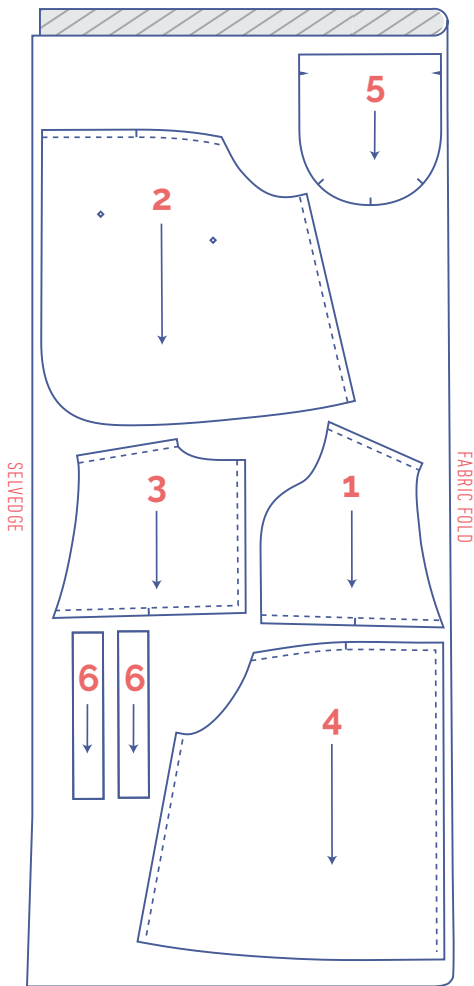

marking pattern pieces

 notch the paper pattern and fabric at the following points

 single notch

 double notch

 V-notch/fabric fold

 mark the following centre points with marking thread

 centre point

bias tape version

fabric layout for solid fabrics
fabric width 140 cm

XS - L

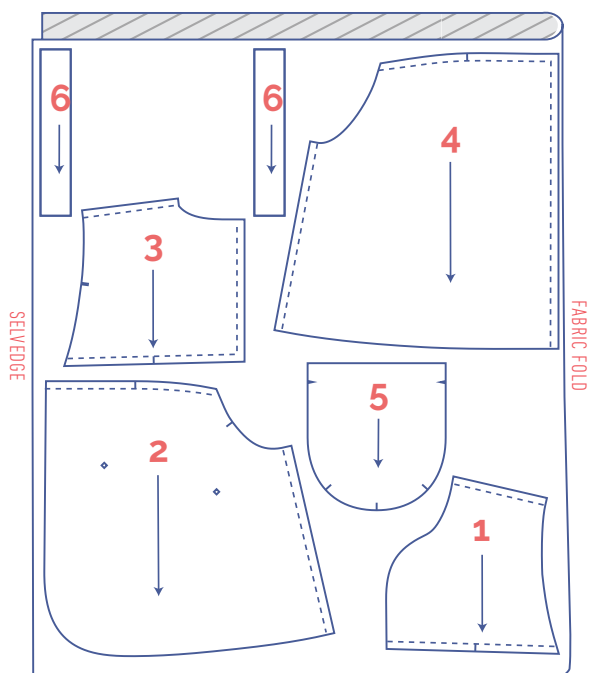

XL - XXXL

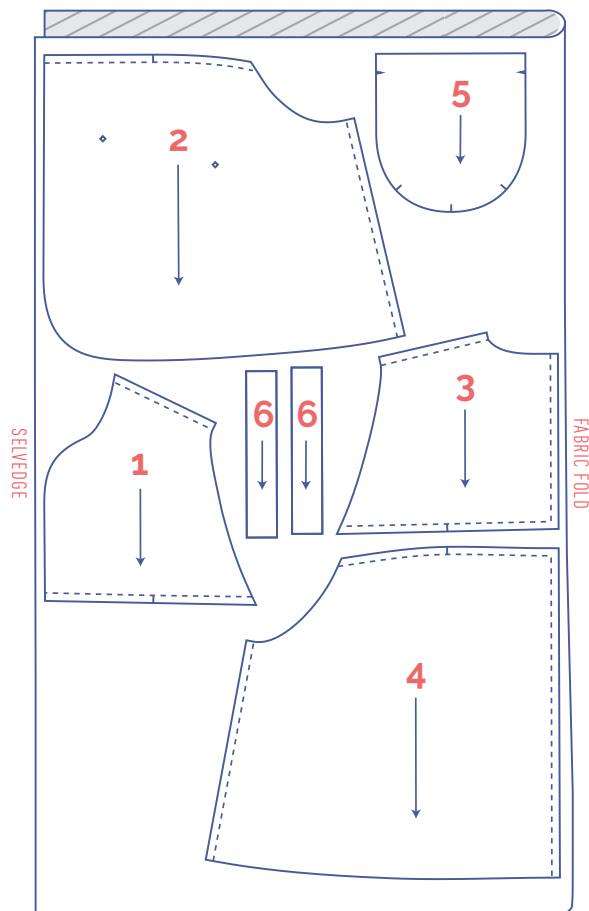

marking pattern pieces



notch the paper pattern and fabric at the following points

I single notch

II double notch

V V-notch/fabric fold



mark the following centre points with marking thread

● centre point

lined version

fabric layout for solid fabrics
fabric width 110 cm

XS - S

M - XL

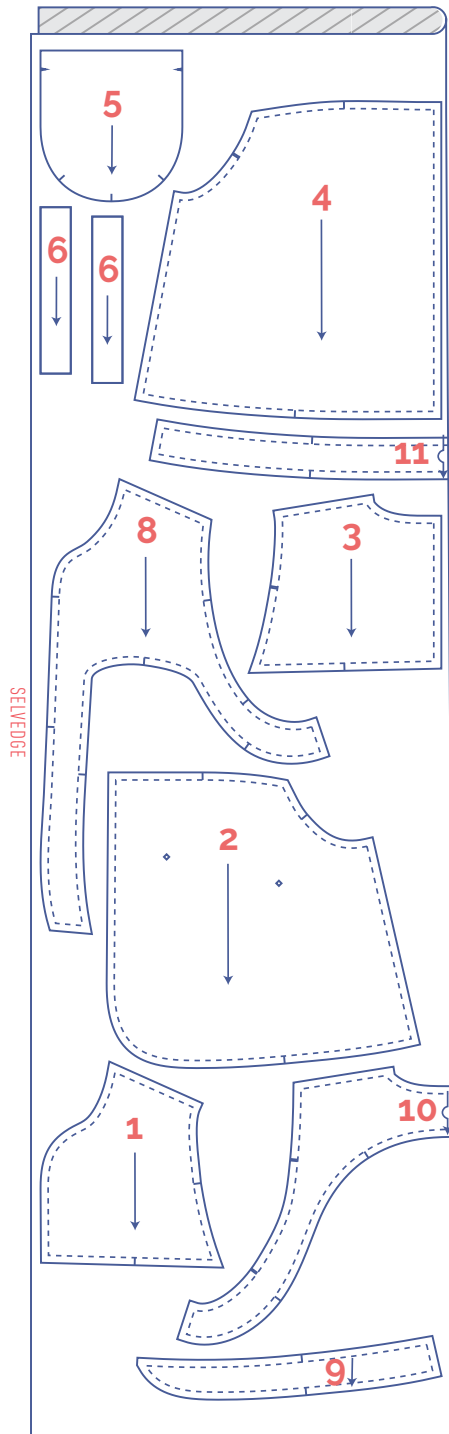
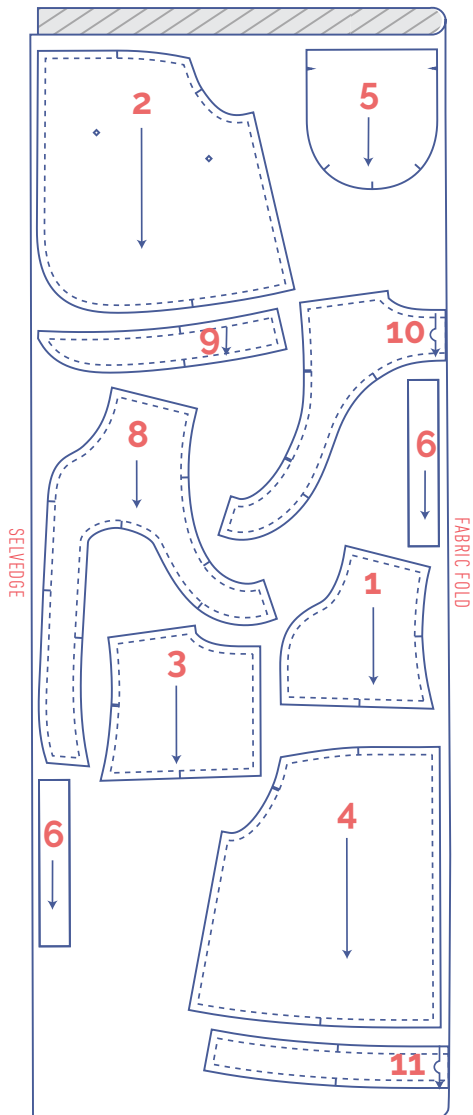

lined version

fabric layout for solid fabrics
fabric width 110 cm

XXL - XXXL

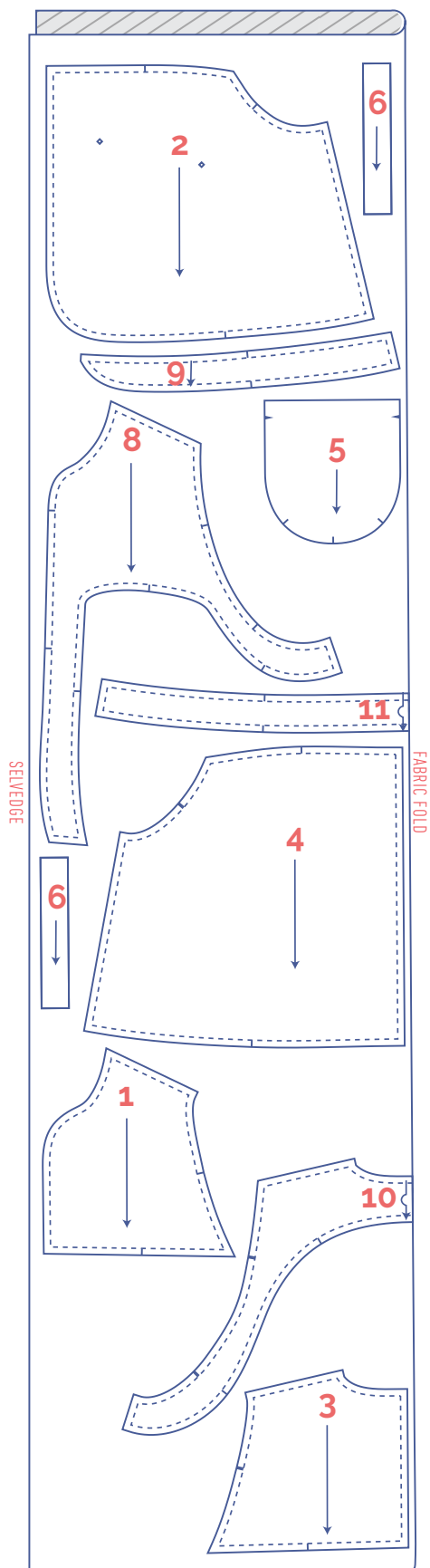

lining fabric layout
fabric width 110 cm

XS - XXXL

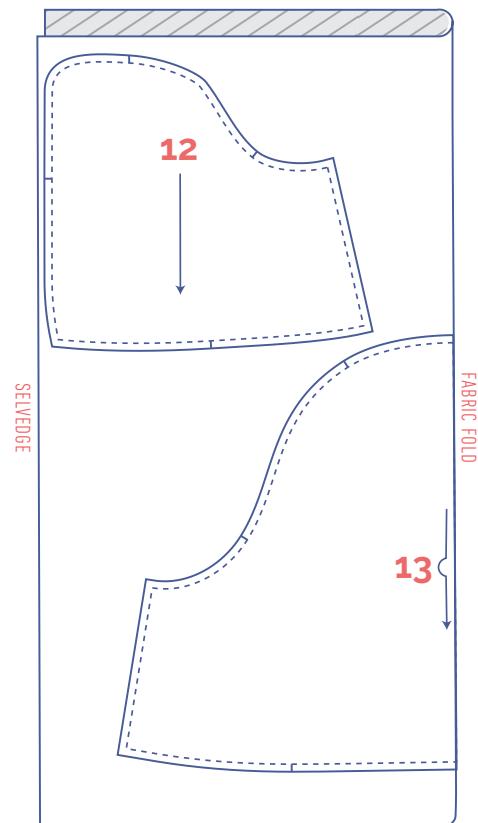

marking pattern pieces



notch the paper pattern and fabric at the following points



single notch



double notch



V-notch/fabric fold



mark the following centre points with marking thread



centre point

lined version

fabric layout for solid fabrics
fabric width 140 cm

XS - S

M - XL

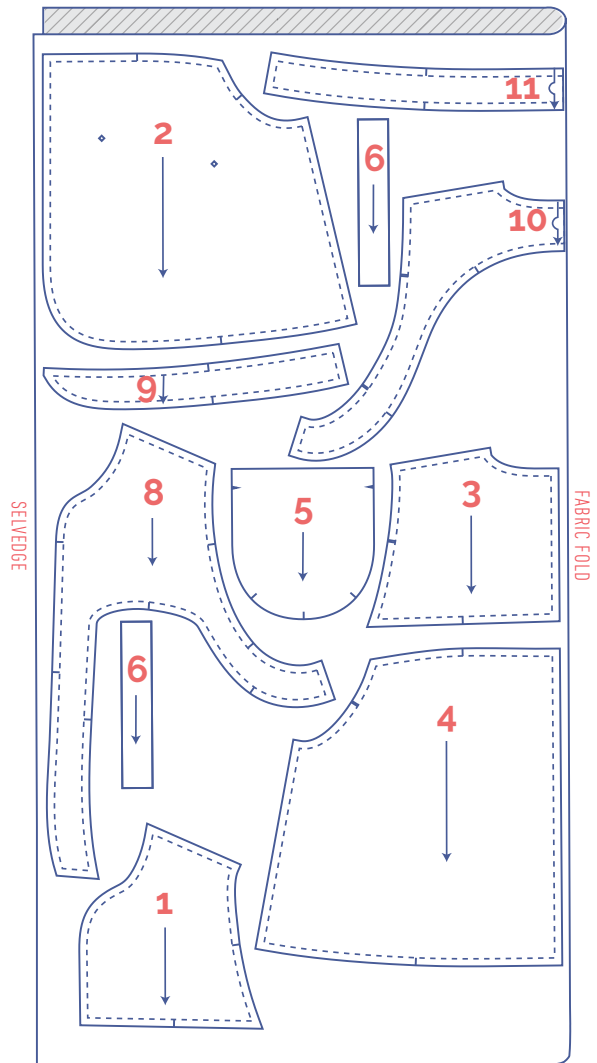
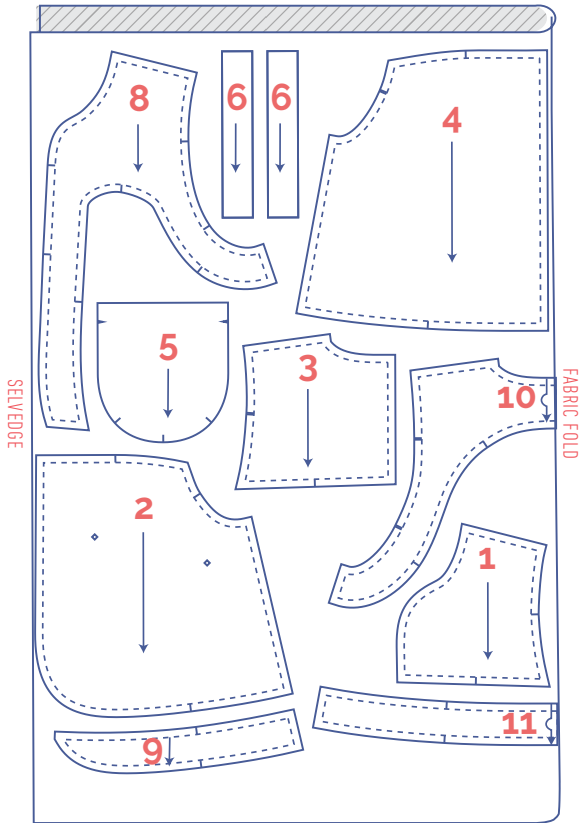

lined version

fabric layout for solid fabrics fabric width 140 cm

XXL - XXXL

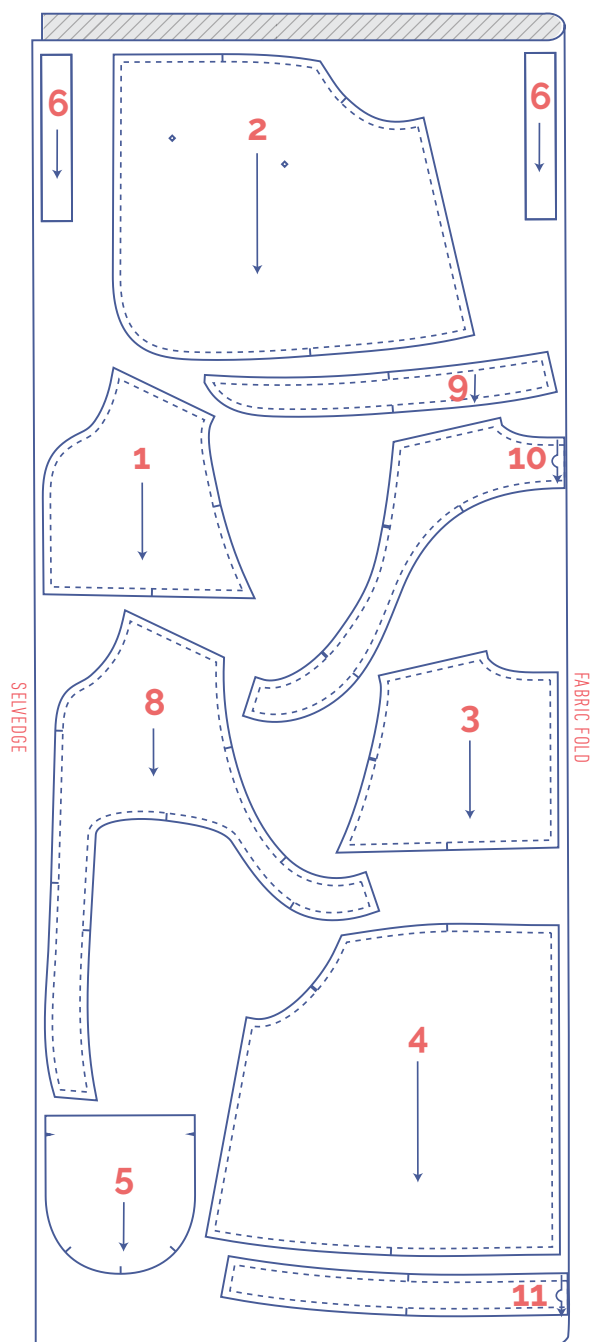

lining fabric layout fabric width 140 cm

XS - XXXL

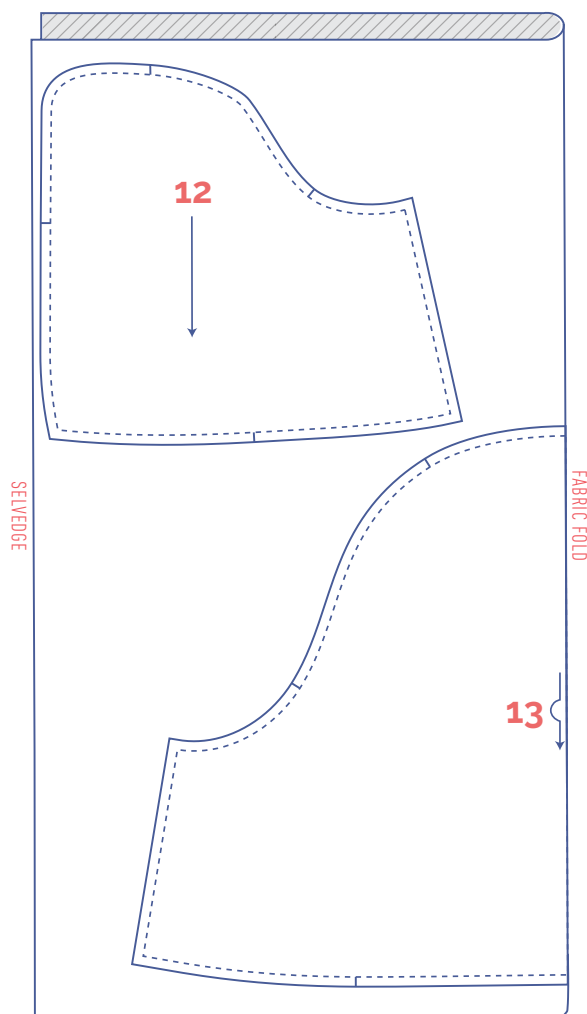

marking pattern pieces

 notch the paper pattern and fabric at the following points

I single notch

II double notch

V V-notch/fabric fold

 mark the following centre points with marking thread

 centre point

sewing instructions



The method used to finish sewing the garment depends on the fabric used. The pieces are always sewn together with the right sides of the fabric facing, unless stated otherwise.

F front

B back

CF centre front

CB centre back

RF right front 

LF left front 

 right side

 wrong side

 lining right side

 lining wrong side

 iron-on interfacing

 bias tape

1

Finish the top of the pocket (5) with overlock stitching.

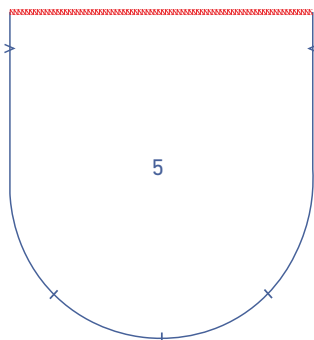

Press/fold the top towards the wrong side at the V-notches.

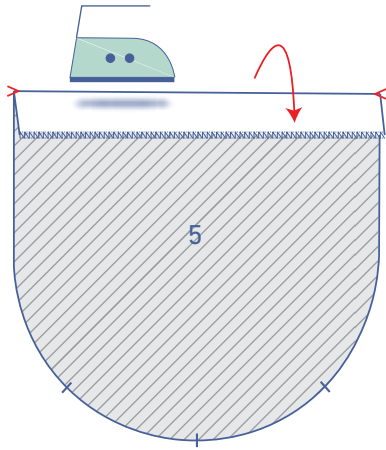

Sew into place.

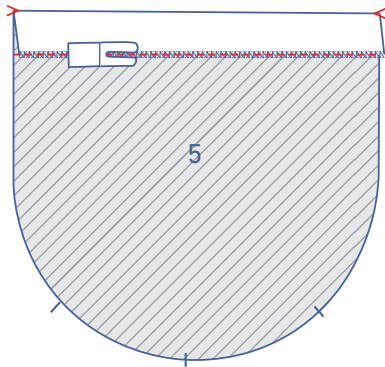

Finish the remaining edges with overlock stitching.

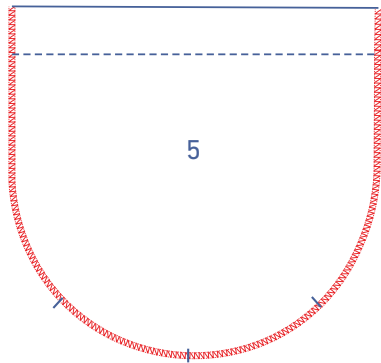

Press/fold these edges 1 cm to the wrong side to create a fold line.

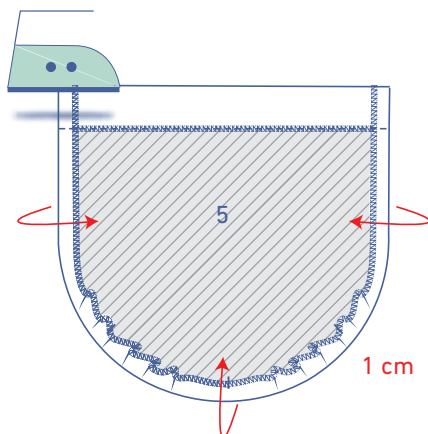

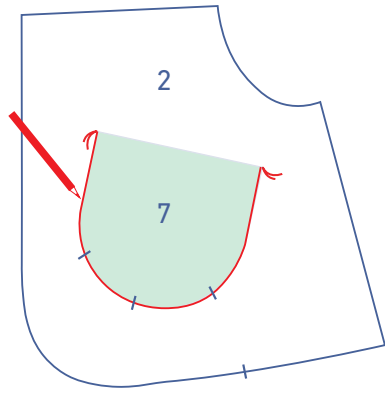

2.1 Blind patch pocket version

Place the template for the pocket (7) on the front bottom piece (2). Use tailor's chalk to trace around the contours of the pocket and the markings. You will sew the seam allowance of the pocket along these lines.

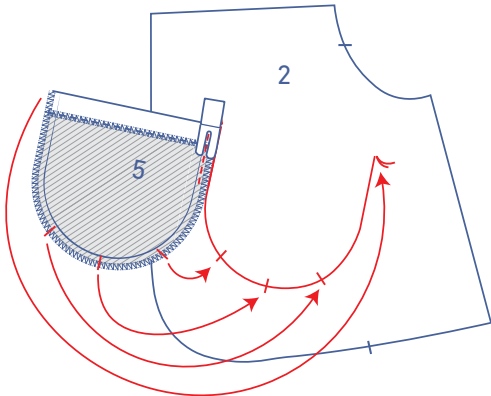

Blind stitch the pocket as follows: place the seam allowance of the pocket on the chalkline and stitch into place at presser foot width. Gradually slide the pocket over so that the whole seam allowance lines up with the chalkline. The markings in the curve and in the centre should line up perfectly. Sew into place until you've reached the other side of the pocket. It may seem like a lot of work, but stay focussed on keeping the overlocked edge on the chalkline and making sure the marks match perfectly.

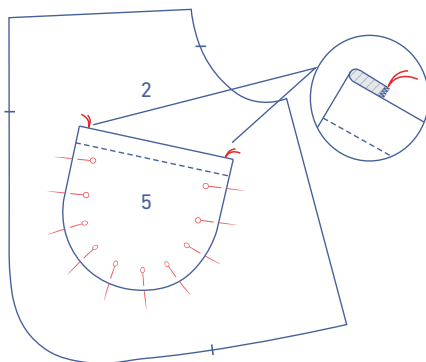

2.2 Patch pocket version

Pin the pocket to the front bottom pieces (2) where indicated, with the seam allowance tucked under the pocket. The overlocked edge of the pressed seam allowance lies against the marking threads.

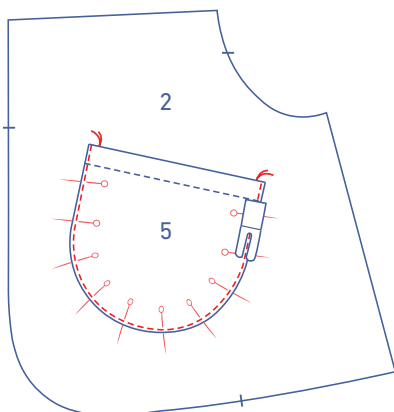

Edgestitch into place.

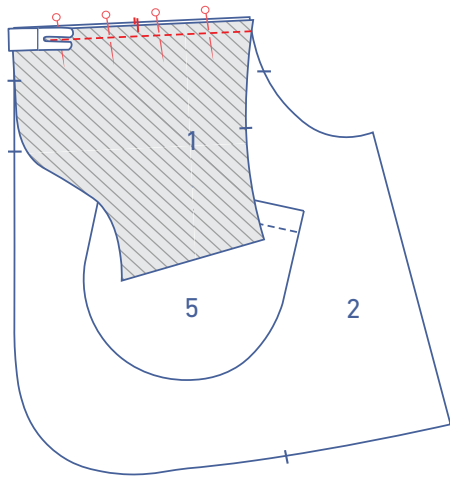

3

Remark

If you make a lined version, you don't need to overlock the raw edges together.

Pin and sew the bodice front (1) to the bottom piece front, right sides together.

Finish the raw edges together with overlock stitching. Press/fold the seam allowance towards the top.

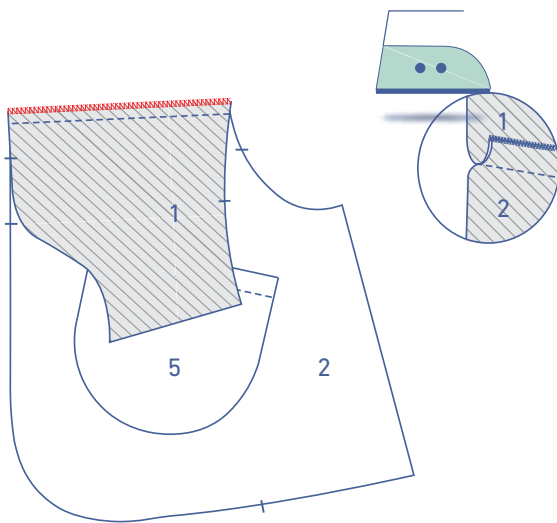

4

Remark

If you make a lined version, you don't need to overlock the raw edges together.

Pin and sew the bodice back (3) and bottom piece back (4), right sides together.

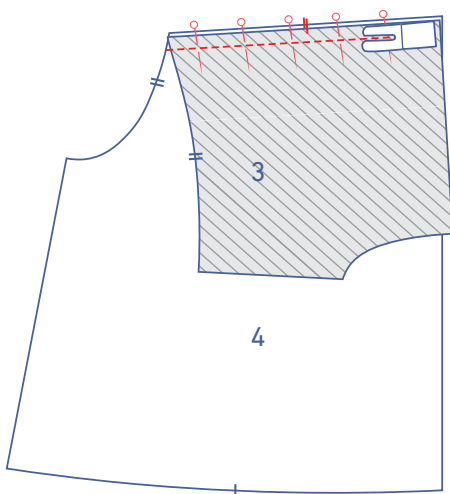

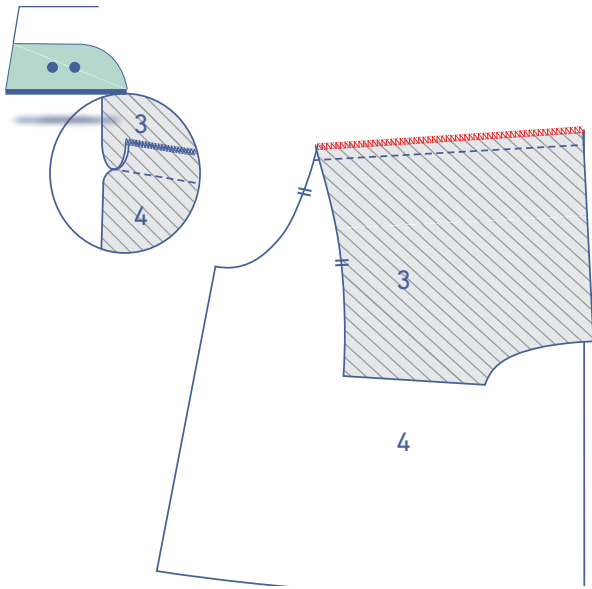

Finish the raw edges together with overlock stitching.
Press/fold the seam allowance towards the top.

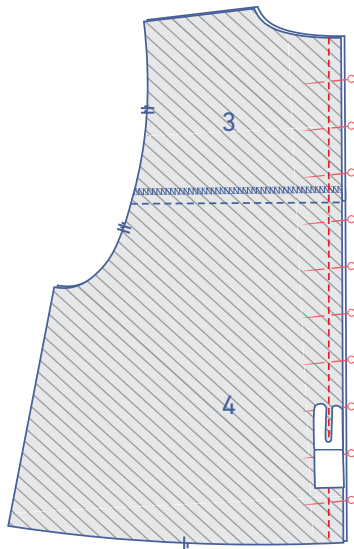

Pin and sew the CB seam.

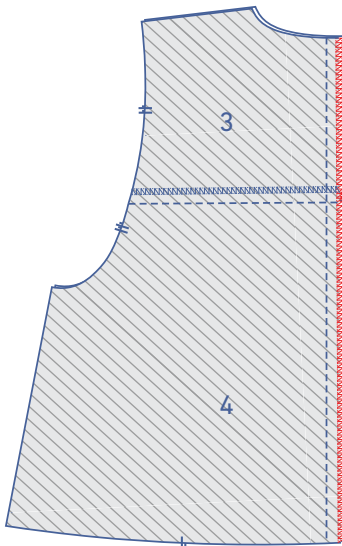

Finish the raw edges together with overlock stitching.

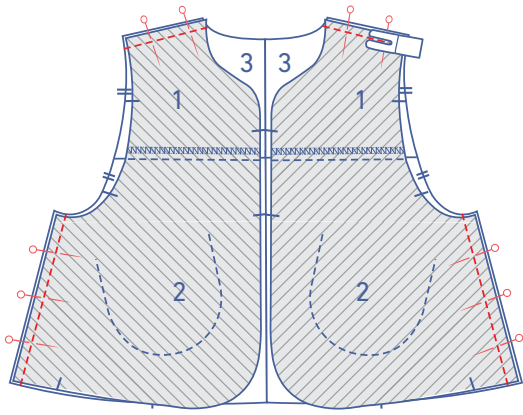

Pin and sew the shoulder and side seams.

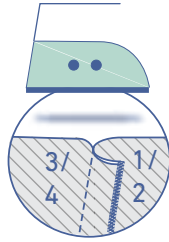

Finish the raw edges together with overlock stitching. Press/fold the seam allowance towards the front.

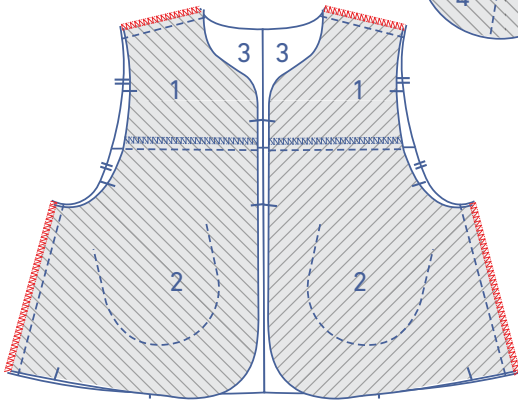

5

Press the ties (6) in half with the long ends together and the wrong sides together. Open back out.

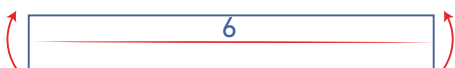
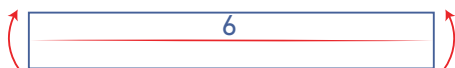
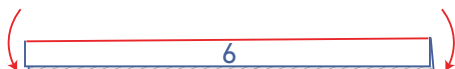
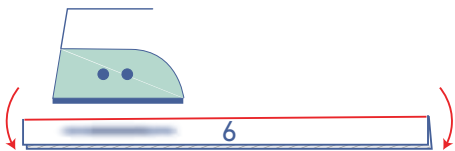

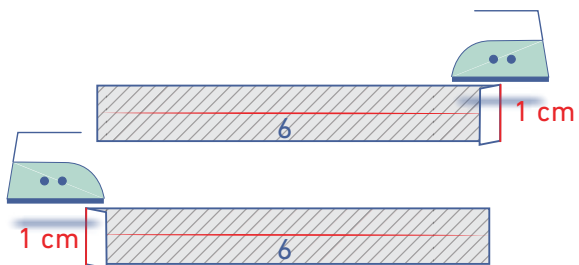

Press one of the short ends 1 cm over towards the wrong side.

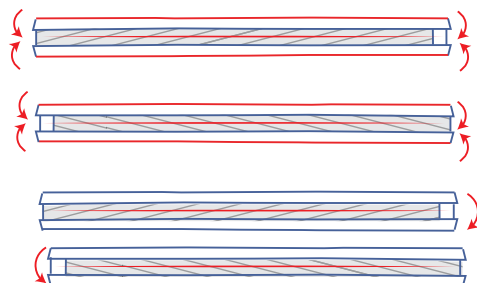

Then, press the long ends to meet the pressed centre line.

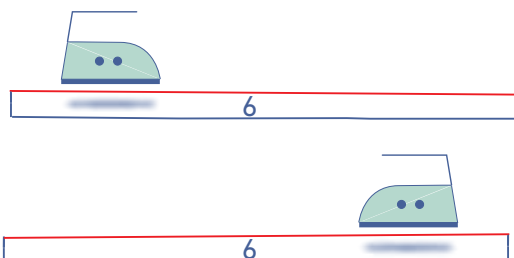

Now, fold back in half along the pressed centre line and press.

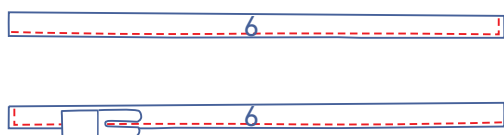

Edgestitch the ends where indicated.

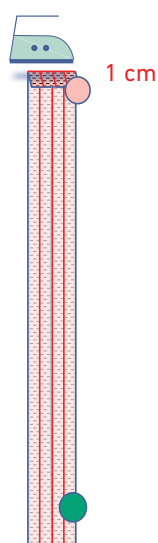

6 Skip this step if you are making a lined version and go immediately to step 8.

Open out the bias tape for the armhole. Press one short end 1 cm towards the wrong side. We've marked this pressed short end with a pink circle. The unpressed short end has been marked with a green circle.

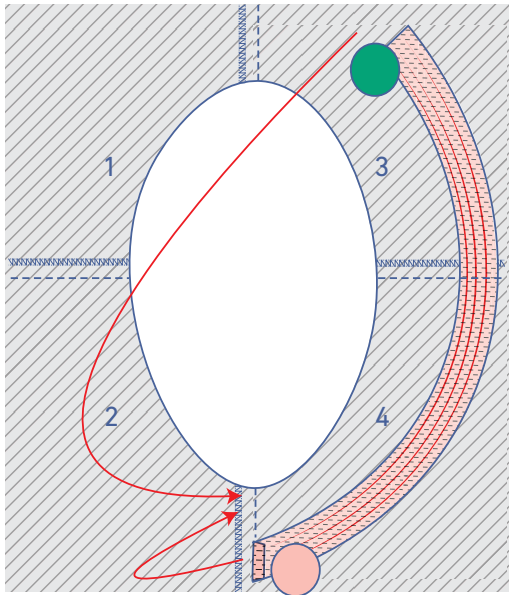

Pin the raw edge of the bias tape to the wrong side of the armhole. The folded end should match the side seam.

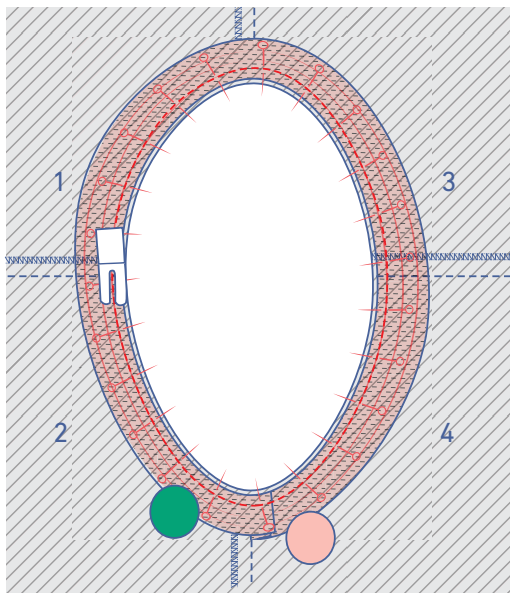

The unfolded end of the bias tape should be on top of the folded end. Trim away any excess bias tape. Sew into place along the first fold line.

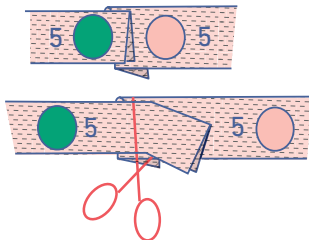

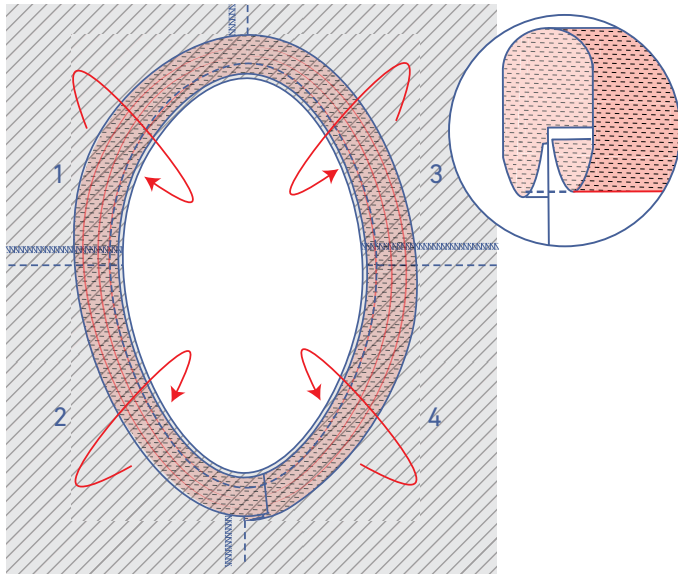

Fold the bias tape over towards the right side at the centre line, tuck the raw edges under and place the pressed edge directly over the previous stitching.

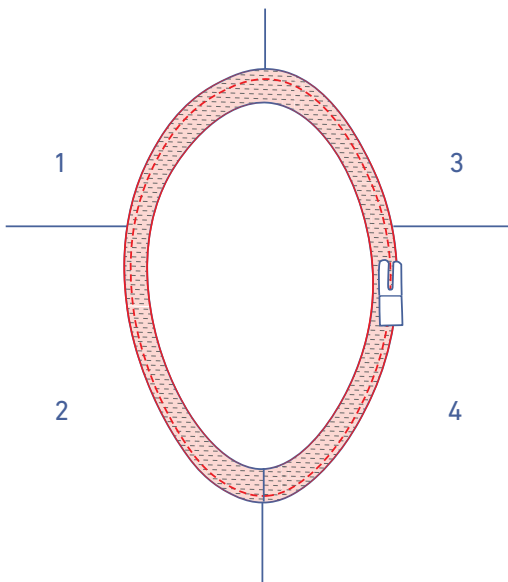

Stitch the bias tape into place right next to the edge.

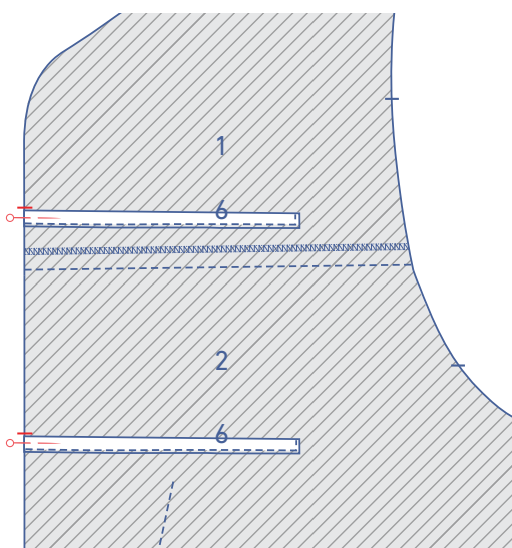

7 Skip this step if you are making a lined version and go immediately to step 8.

Pin the raw edge of the ties to the wrong side of the front. The top of the ties match the indicated notches.

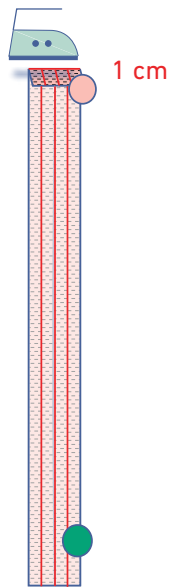

Open out the bias tape for the neck and hemlines. Press one short end 1 cm towards the wrong side. We've marked this pressed short end with a pink circle. The unpressed short end has been marked with a green circle.

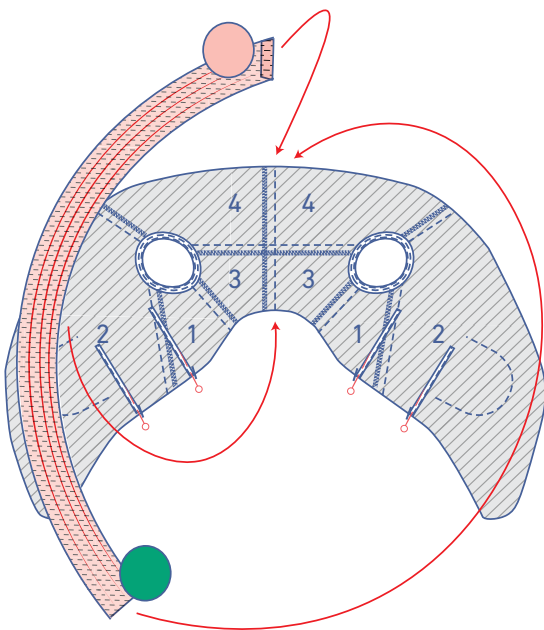

Pin the raw edge of the bias tape to the wrong side of the garment. Align the folded end (pink circle) with the CB seam.

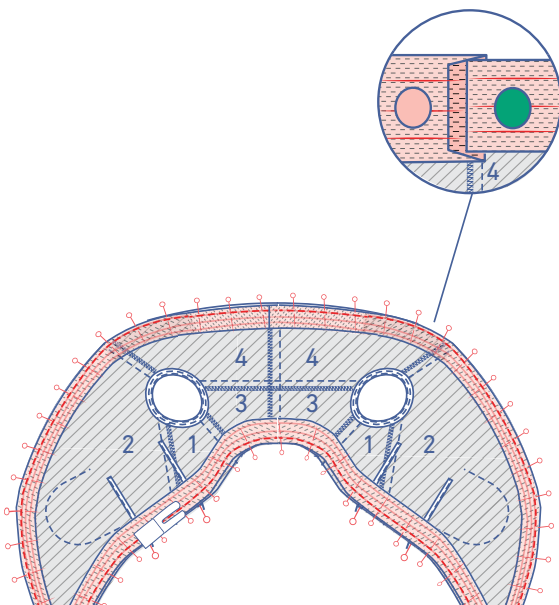

The unfolded end of the bias tape should be on top of the folded end. Trim away any excess bias tape. Sew into place along the first fold line.

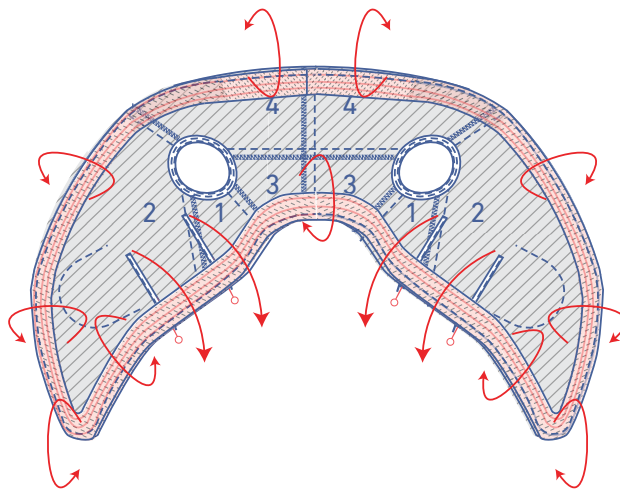

Fold the bias tape over towards the right side at the centre line, tuck the raw edges under and place the pressed edge directly over the previous stitching. Arrange the ties so that they lie away from the garment (see next illustration).

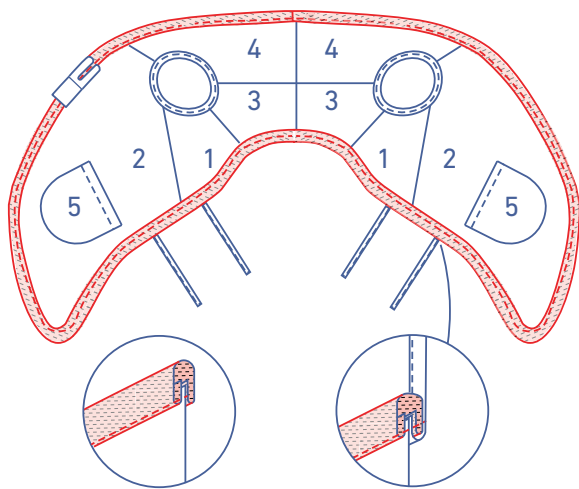

Edgestitch the bias tape into place and also sew along the ties so they stay in the direction indicated.

8 The following steps are only for the lined version.

Pin and sew the front facing (8) and the front lining (12) pieces together, with the markings matching.

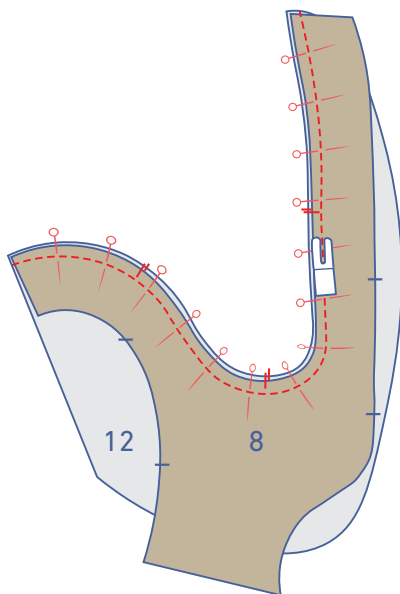

Pin and sew the hem facing front (9) to the lining + facing with the markings matching.

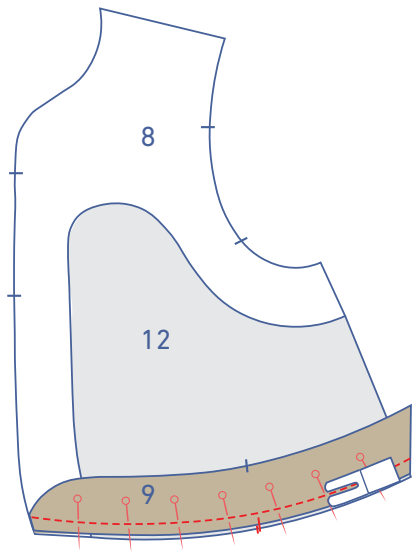

Pin and sew the back facing (10) and the back lining (13) pieces together, with the markings matching.

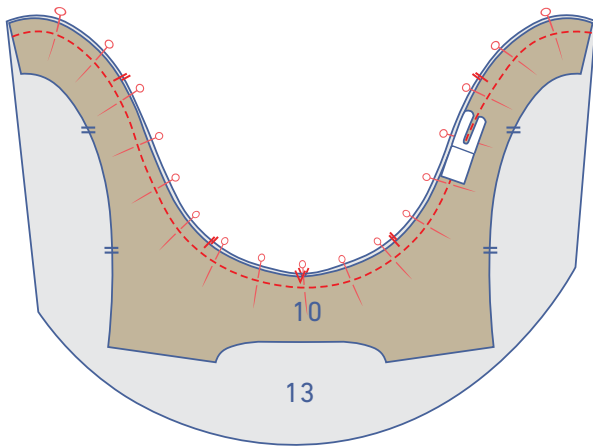

Pin and sew the hem facing back (11) to the back lining with the markings matching.

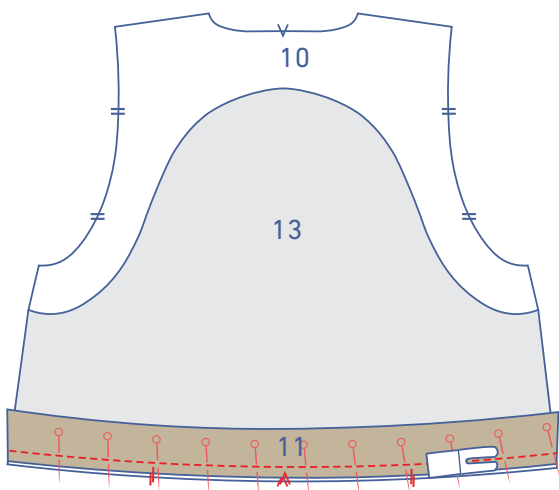

Pin and sew the shoulder seams of the facing pieces together. Press the seam allowance towards the back.

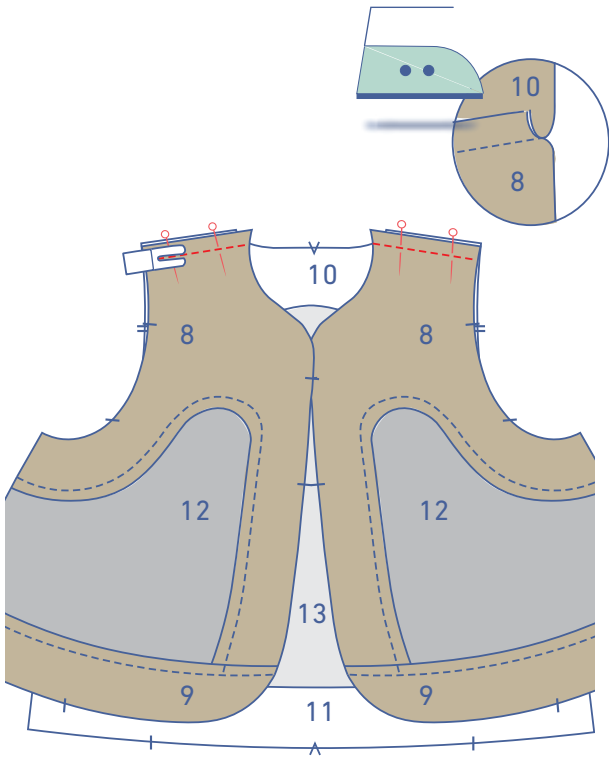

Pin and sew the side seams, but leave an opening in one of the side seams to turn the bodywarmer the right way out later. Press the seam allowance open.

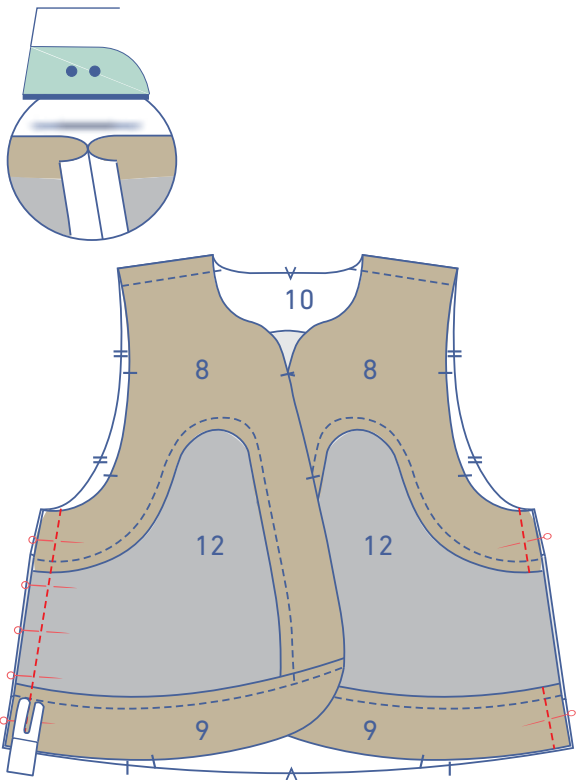

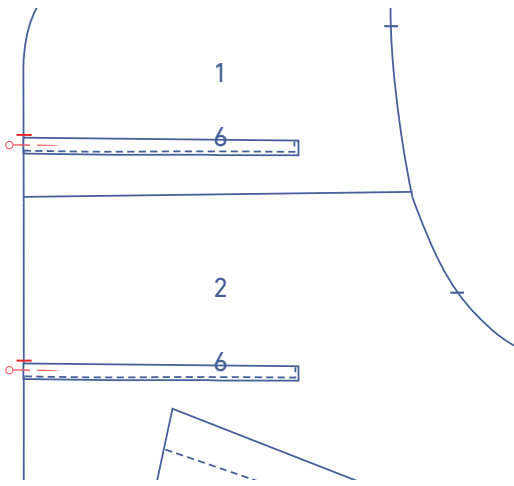

9

Pin the raw edge of the ties to the right side of the front. The top of the ties match the indicated notches.

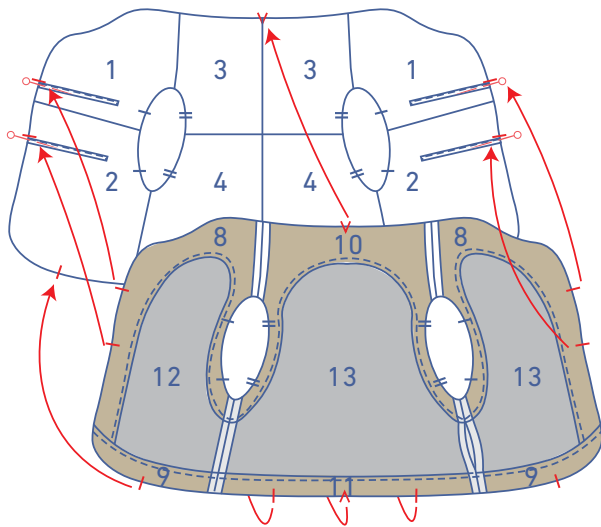

Place the facing/lining on top of the body, right sides together, matching markings

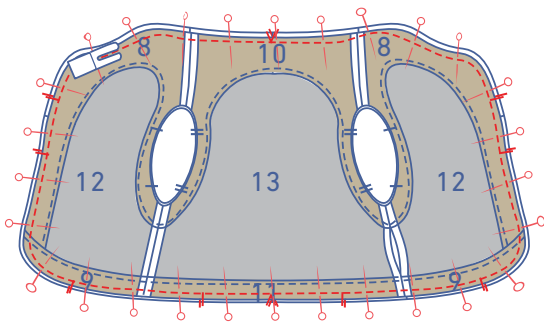

Pin the contours together and sew into place.

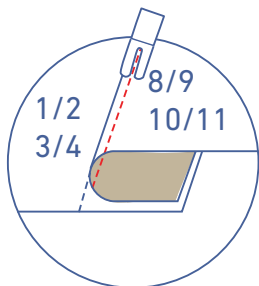

Sew the bodywarmer in lining (facing + lining) to the seam allowance underneath, anchoring it right next to the seam (through the armholes).

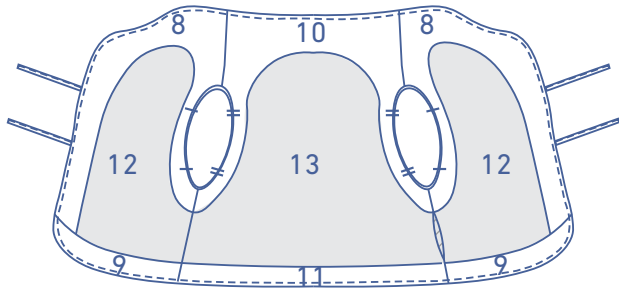

10

Turn the right way out.

Arrange the armhole of the body/lining into its final position. Now put your hand in the lining hole and pull through the two layers of the armhole (right sides together).

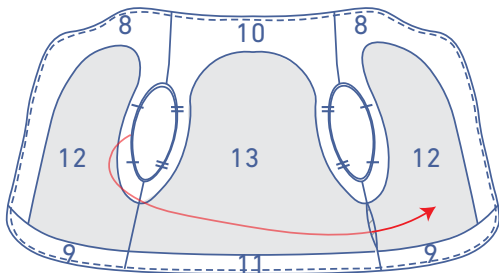
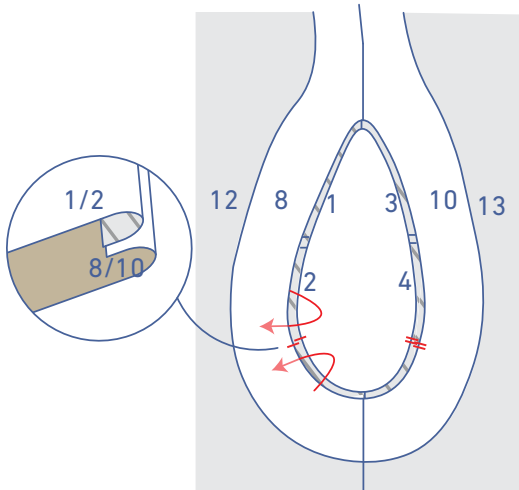

Match the seam allowance of the armholes neatly, with the right sides together and start to pin the raw edges of the armhole.

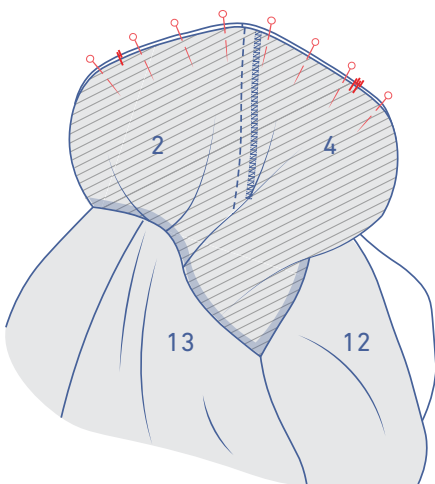

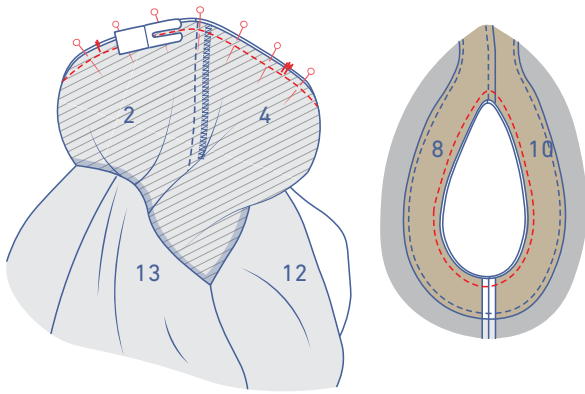

Sew all the way around the armholes. Do this in 2-cm increments: match the raw edges and sew approx. 2 cm. Line up the raw edges again and sew another 2-cm increment, etc. Continue until you've sewn all the way around.

11

Hand stitch or sew the seam allowances of the facing pieces to the seam allowances of the side seams/CB seam.

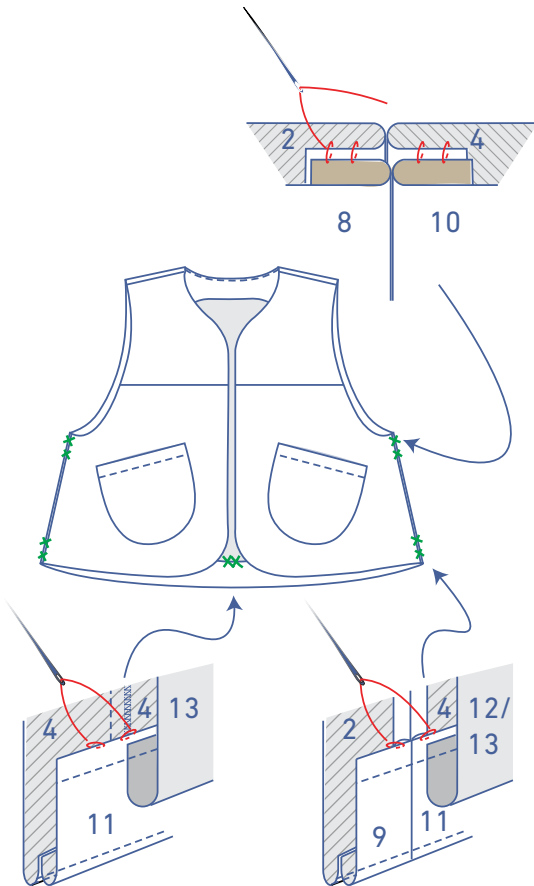

Hand stitch or sew the opening in the lining closed.

