

# Pipa by Fibre ⚡ood



# Pipa by Fibre Mood



0 - 28

Oh Pipa, you were made for summer garden parties! This stylish sundress has a lovely, fitted bodice due to inverted box pleats, with a skirt that drapes gracefully in an A-line towards the hem. Pipa has adjustable shoulder straps and an invisible zip in the side seam. If you feel like the bodice offers enough support, you can even omit the shoulder straps for a stunning corset dress.

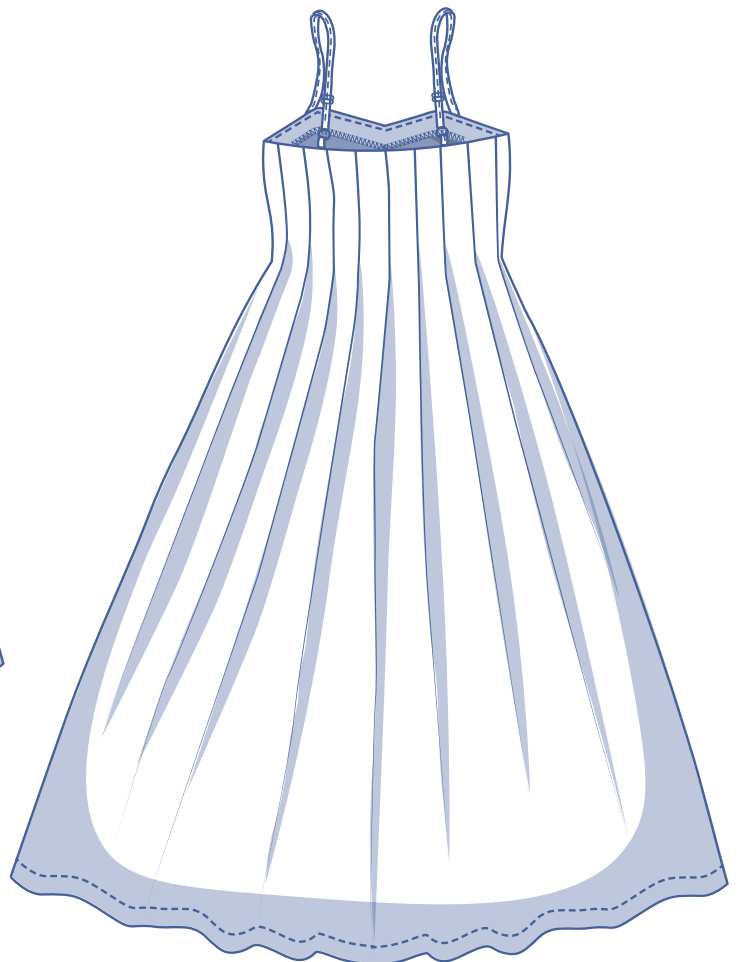
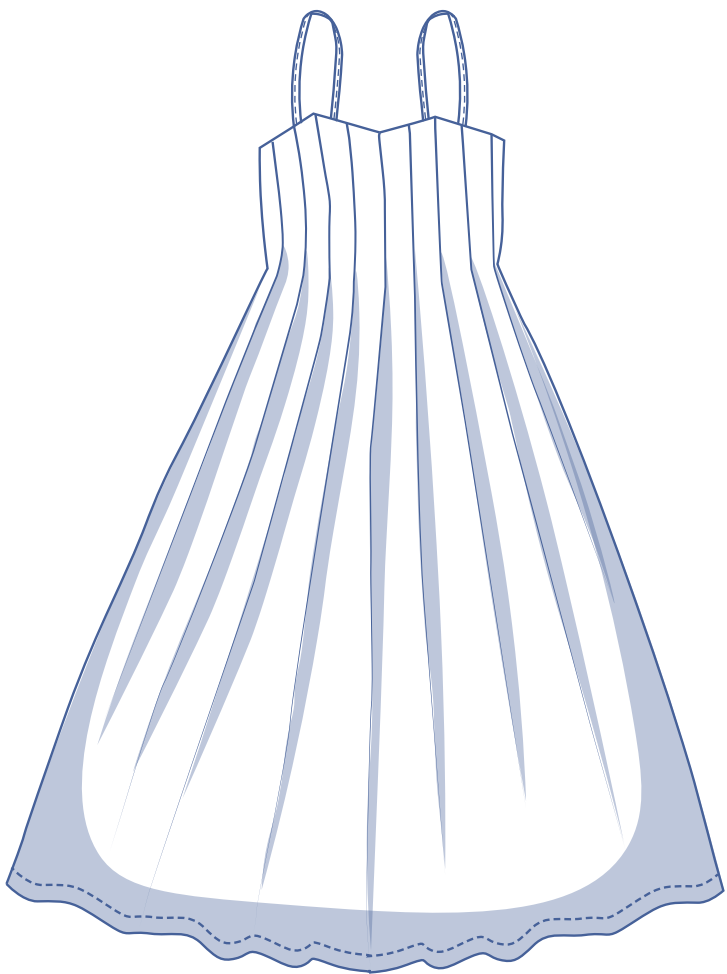

## size chart (in inches)

size	0	2	4	6	8	10	12	14	16	18	20	22	24	26	28
H (height)	5'25"	5'38"	5'45"	5'48"	5'51"	5'54"	5'58"	5'61"	5'64"	5'64"	5'64"	5'64"	5'64"	5'64"	5'64"
B (bust)	29.9	31.5	33.1	34.6	36.2	37.8	39.4	40.9	43.3	45.7	48	50.4	52.8	55.1	57.5
W (waist)	26	26.8	27.6	29.1	30.7	32.3	33.1	34.6	37.2	39.8	42.3	44.9	47.4	50	52.6
H (hips)	33.9	35.4	37	38.2	39.4	40.6	41.7	42.9	45.3	47.2	49.2	51.2	53.1	55.1	57.1

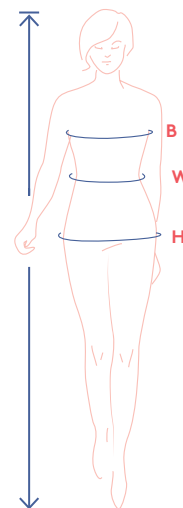

Choose your size based on your **bust measurement**. If your waist measurements are wider than those in the size chart, check the waist measurements in the chart below to see if there's enough room or whether the pattern needs to be altered. It's easy to do. Simply trace the line of the one size instead of the other.

## pattern measurements (in inches)

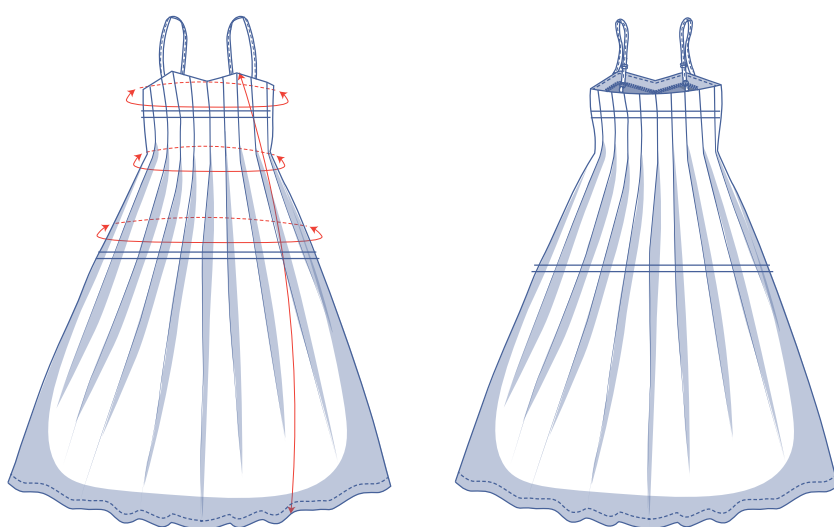

== shorten or lengthen the pattern here

This chart's measurements are the pattern measurements based on the fabric type and serve as a reference. Ease has been added to the width measurements (in addition to the exact body measurements) for a more comfortable fit. Pipa is designed to be **fitted at the bust and waist, but loose around the hips**. Depending on the preferred cut, you could decide to go a size smaller or larger than the recommended size.

size	0	2	4	6	8	10	12	14	16	18	20	22	24	26	28
length*	42.4	42.5	42.6	42.6	42.7	42.8	43.7	43.8	45.3	45.4	45.6	45.8	45.9	46.1	46.3
bust**	30.5	32	33.5	35.2	36.8	38.4	39.9	41.6	43.8	46.3	48.8	51.2	53.7	56.2	58.7
waistline	26.8	27.6	28.5	30.1	31.7	33.3	34.1	35.7	38.5	41.1	43.7	46.4	49	51.6	54.2
hips	81.2	82	82.8	90.6	92.2	93.8	94.6	96.2	105	107.6	110.1	119	121.5	124.1	126.7

\* Without shoulder straps.

\*\* With pleats folded.

Compare the stated lengths to the measured or desired lengths. **Lengthen** or **shorten** the dress by cutting the pattern pieces at the indicated double lines. Then either increase the distance between the cut pieces by the desired amount (to lengthen) or overlap the pieces (to shorten). Make sure that the CF and CB lines and the side seams are always straight.



### IMPORTANT

Adjust the amount of fabric to be used based on these alterations.

## notions



- Thread
- Iron-on interfacing: max. 8"
- Bra ring and slider: 2 of each
- Invisible zip: 8"
- Fabric: see table

fabric		0	2	4	6	8	10	12	14	16	18	20	22	24	26	28
fabric width 43"	yd	4	4	4	4	4	5	5 ¼	5 ¼	5 ¼	5 ¼	5 ½	5 ½	5 ½	5 ½	5 ½
fabric width 55"	yd	2 ½	2 ½	2 ¾	2 ¾	2 ¾	4	4	4	4 ¼	4 ¼	4 ¼	5 ¼	5 ½	5 ½	5 ½

The corresponding fabric layout can be found on page 6 of these sewing instructions.

## fabric advice



Pipa's pleats are easiest to create in poplin and other stiff fabrics; however, summery linen, romantic silk, or Broderie Anglaise are also great options.

# Proud to be #Sewista

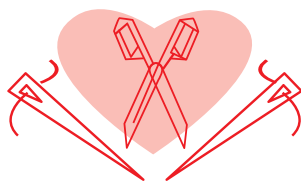

## pattern pieces & seam allowances (in inches)

To sew the garment as described in the instructions, draw the illustrated seam allowances around the paper pattern pieces before cutting them out. If you are using a PDF pattern, the pattern can be printed with or without seam allowance.

To find out more, watch the [video](#).

1. front: 2x
2. back: 2x
3. pocket: 4x
4. facing front: 1x on fabric fold
5. facing back: 1x on fabric fold
6. shoulder strap A: 2x
7. shoulder strap B: 1x

**IMPORTANT**

The pieces highlighted in light yellow have iron-on interfacing attached to the wrong side.

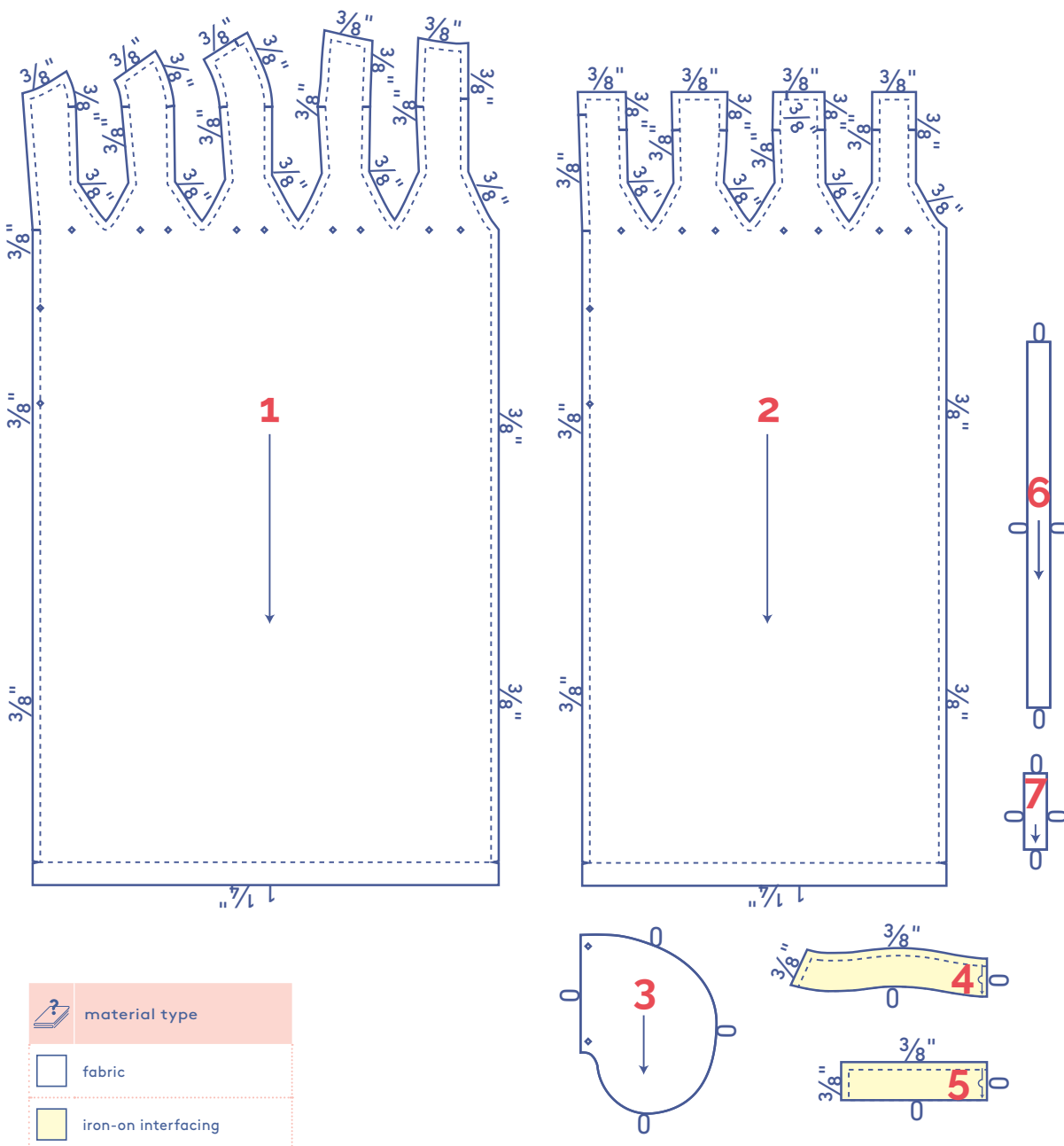

**fabric layout – solid fabrics**  
**fabric width 43"**

0 - 8

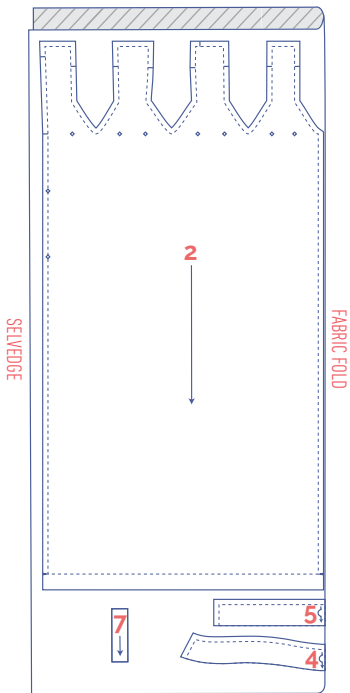

**IMPORTANT**  
 You only need pattern piece 7 once.

10 - 28

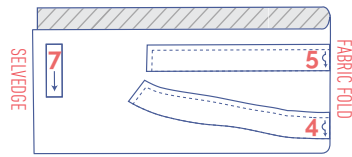

**IMPORTANT**  
 You only need pattern piece 7 once.

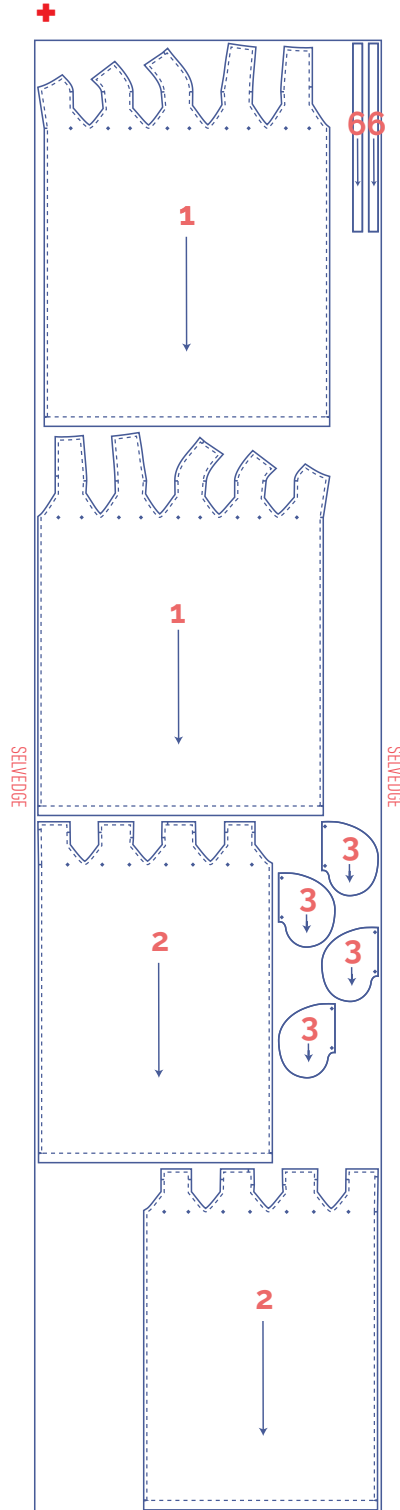
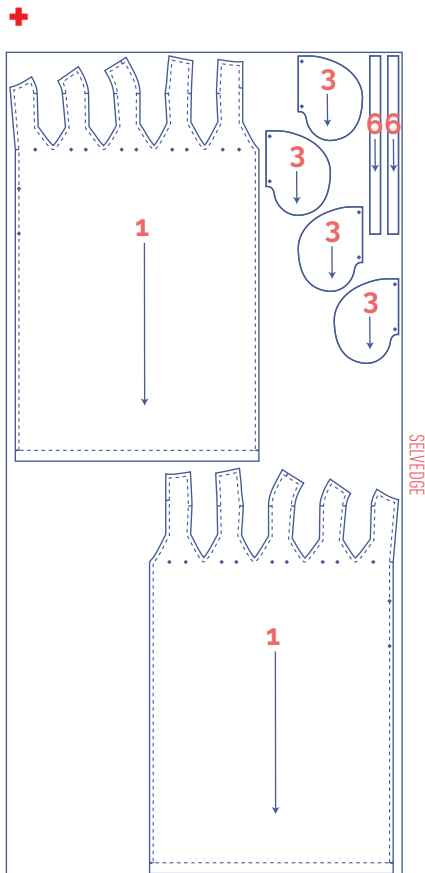

**fabric layout – solid fabrics**  
**fabric width 55"**

0 - 8

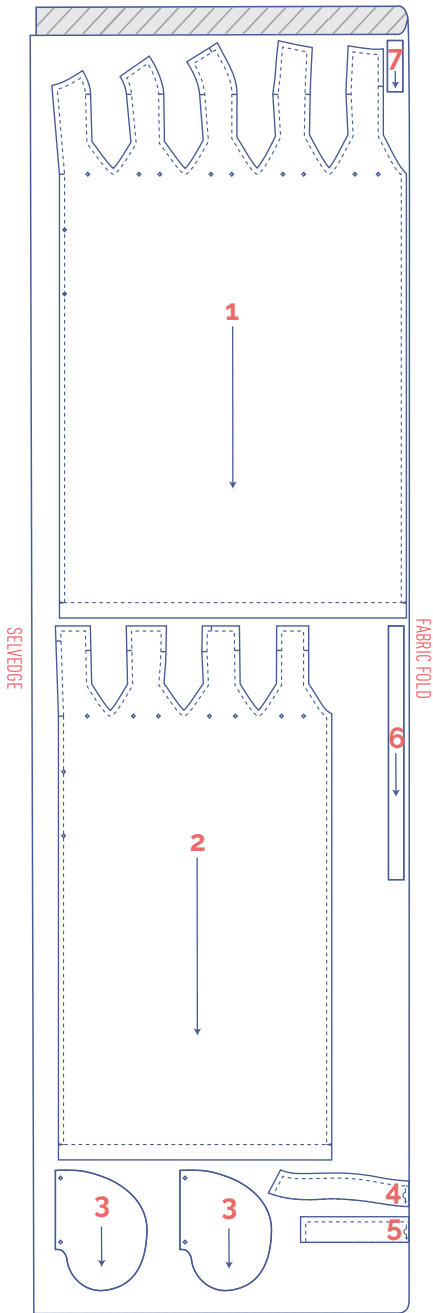

**IMPORTANT**  
 You only need pattern piece 7 once.

10 - 20

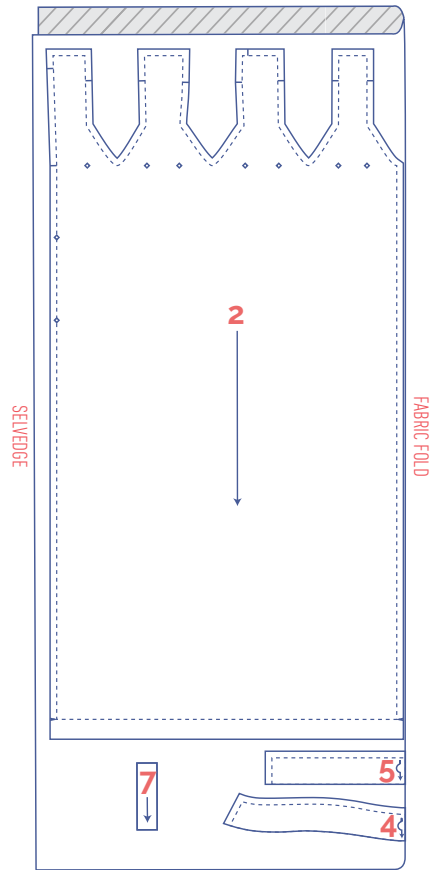

**IMPORTANT**  
 You only need pattern piece 7 once.

+

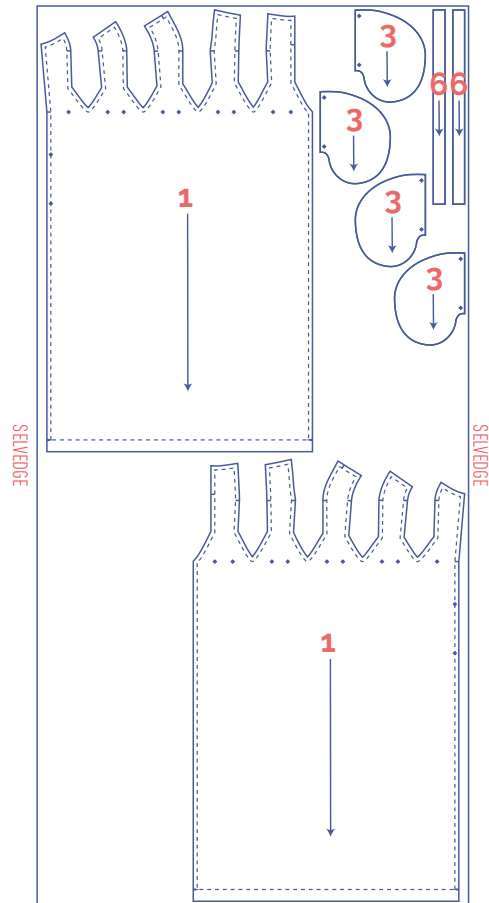

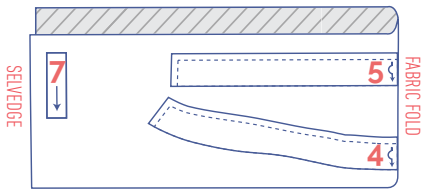

**IMPORTANT**

You only need pattern piece 7 once.

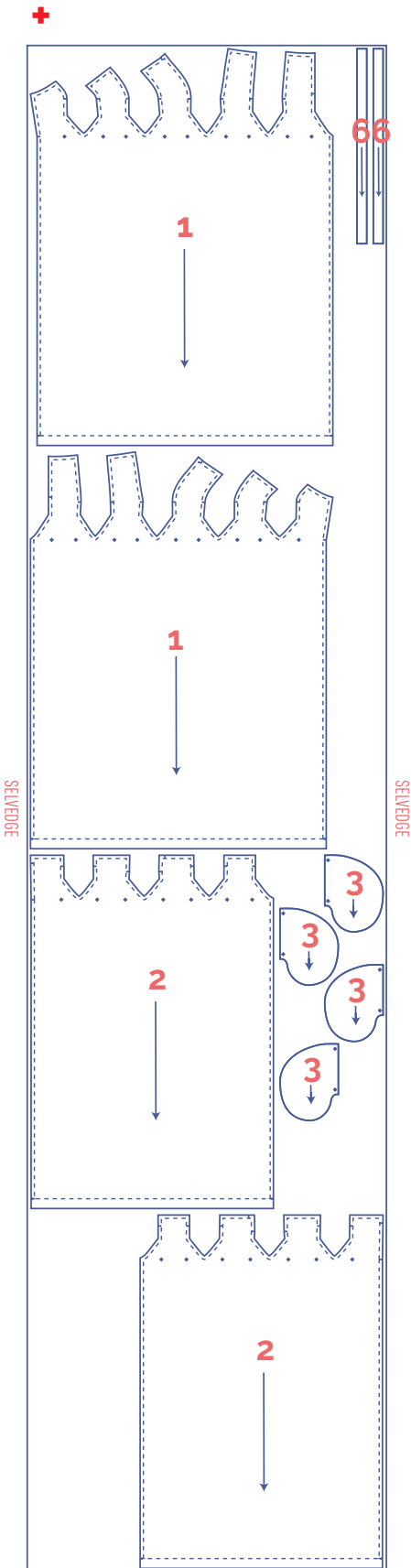

**marking pattern pieces**

	Notch the pattern paper and fabric at the following points
	single notch
	double notch
V	V notch
	Mark the following points using marking thread
	centre point



# sewing instructions



The method used to finish the seams depends on the fabric used.  
The pieces are always sewn together with the right sides of the fabric facing, unless stated otherwise.

F front

B back

CF centre front

CB centre back

 right side

 wrong side

 iron-on interfacing

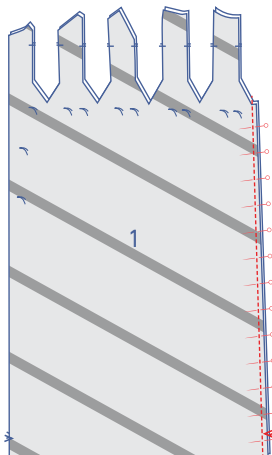

**1**

Pin and sew the CF seam of the front (1).

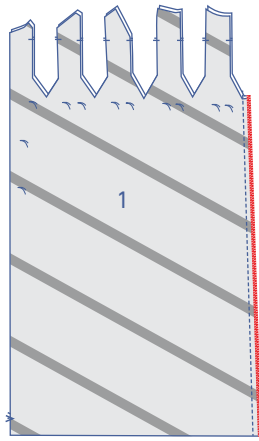

Finish the raw edges with overlock stitching.

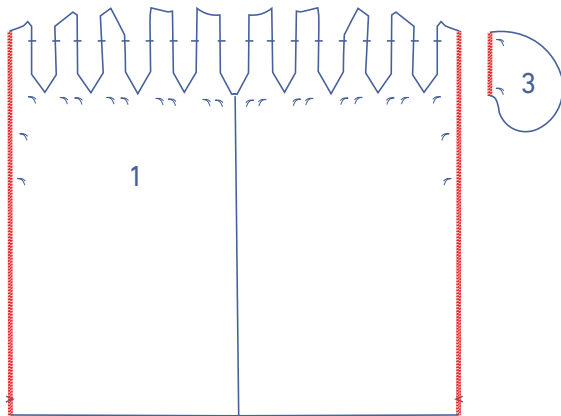

Finish the side seams of the front and the straight edges of the pocket pieces (3) with overlock stitching.

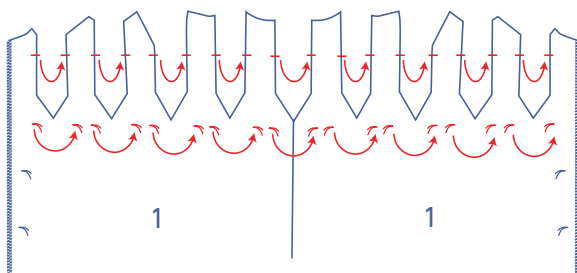

Make the pleats by overlapping the marking threads and notches with the right sides of the fabric touching.

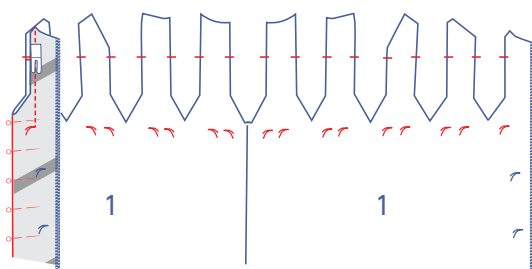
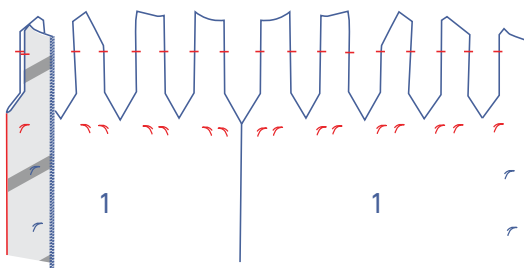

Pin and stitch the pleats vertically into place up to the marking threads.

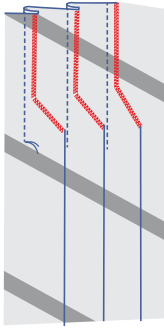

Finish the raw edges with overlock stitching.

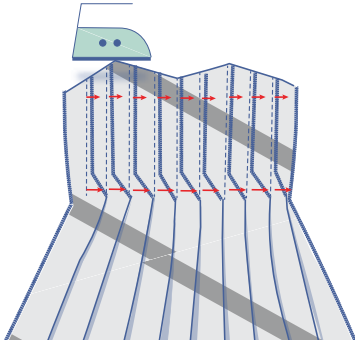

Place the front wrong side facing up and press the pleat allowances in one direction as illustrated.

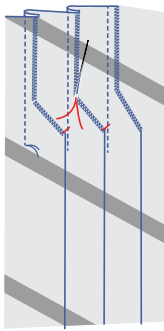

Sew the pleat allowances together with a few stitches by hand.

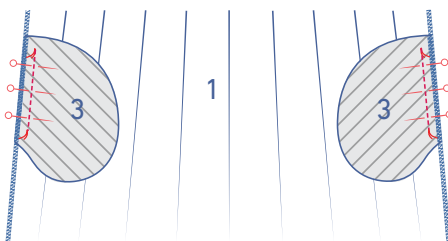

## 2

Pin the straight ends of 2 of the 4 pocket pieces to each side of the front, matching the marking threads, right sides together. Sew into place between the marking threads.

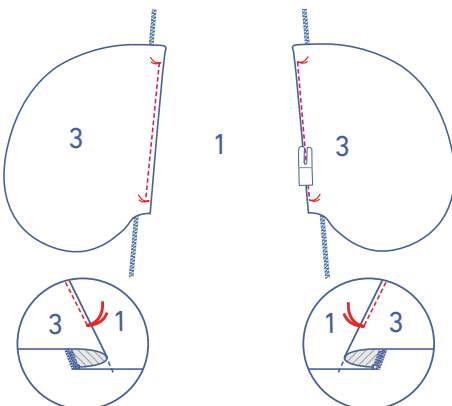

Fold the pocket pieces over and sew the pocket to the seam allowance underneath, between the marking threads and right next to the seam.

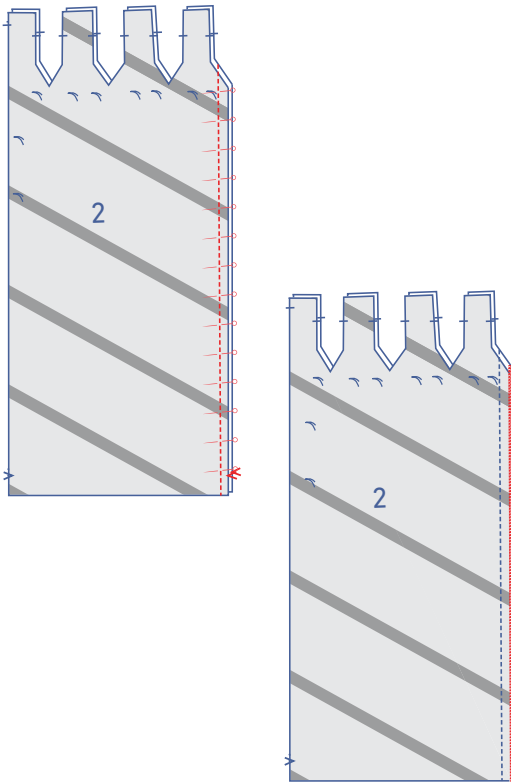

### 3

Pin and sew the CB seam of the back (2).

Finish the raw edges with overlock stitching.

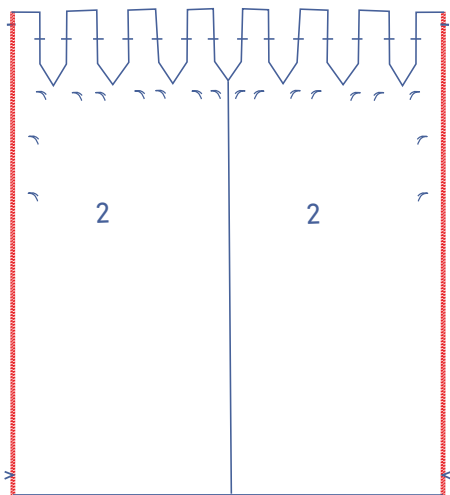

Finish the sides of the back with overlock stitching.

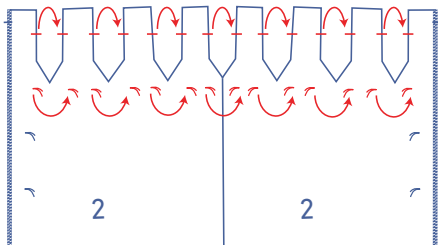

Make the pleats by overlapping each of the marking threads and matching notches with the right sides of the fabric touching.

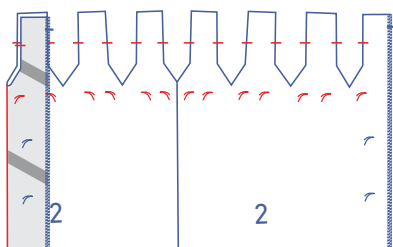

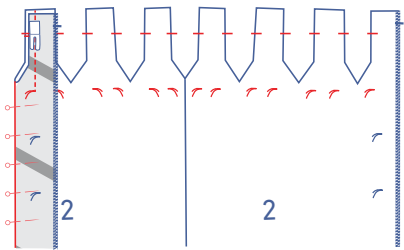

Pin and stitch the pleats vertically into place up to the marking threads.

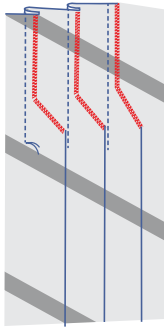

Finish the raw edges with overlock stitching.

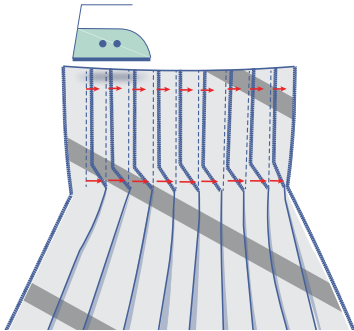

Place the back in front of you with the wrong side facing up. Press the pleat allowances in the direction indicated.

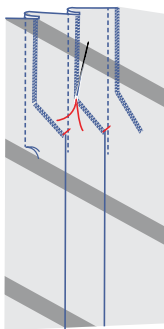

Sew the pleat allowances together with a few stitches by hand.

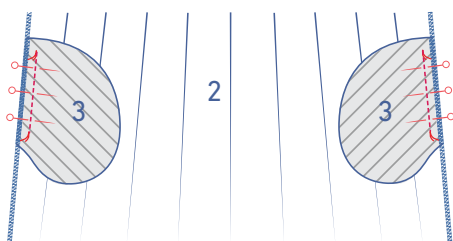

**4**

Pin the straight ends of the 2 remaining pocket pieces to the side of the back, matching the marking threads. Sew into place between the marking threads.

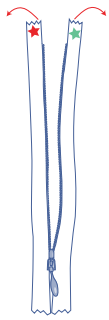

## 5

Place the invisible zip in front of you with the right side facing up. Open the zip.

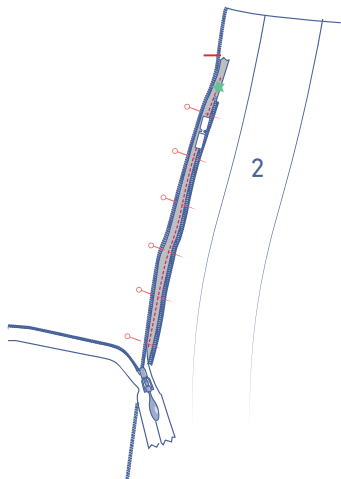

Now, fold the green star zip tape to the right and pin it to the side seam of the back. The zip tape should align with the edge of the fabric and the top of the zip teeth should be level with the single notch. Sew into place using the invisible zipper foot.

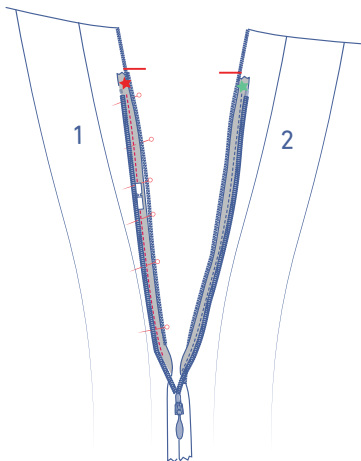

Now, fold the red star zip tape to the left and pin it to the side seam of the front. The zip tape should align with the edge of the fabric, with the top level with the single notch. Sew into place using the invisible zipper foot.

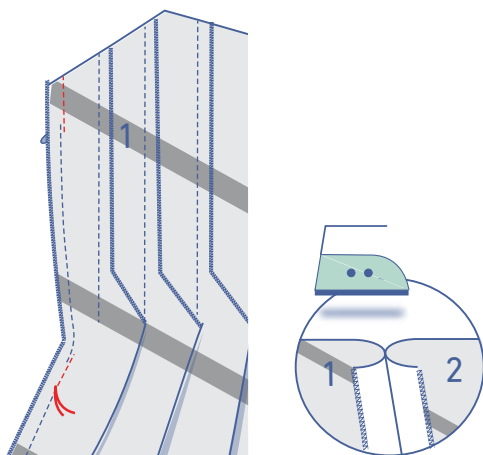

Close the zip and stitch the rest of the side seam into place above and below the zip with the zipper or narrow presser foot. Keep stitching past the bottom of the zip, slightly above and to the side of the zip tape. Sew up to the marking thread that marks the top of the pocket opening.

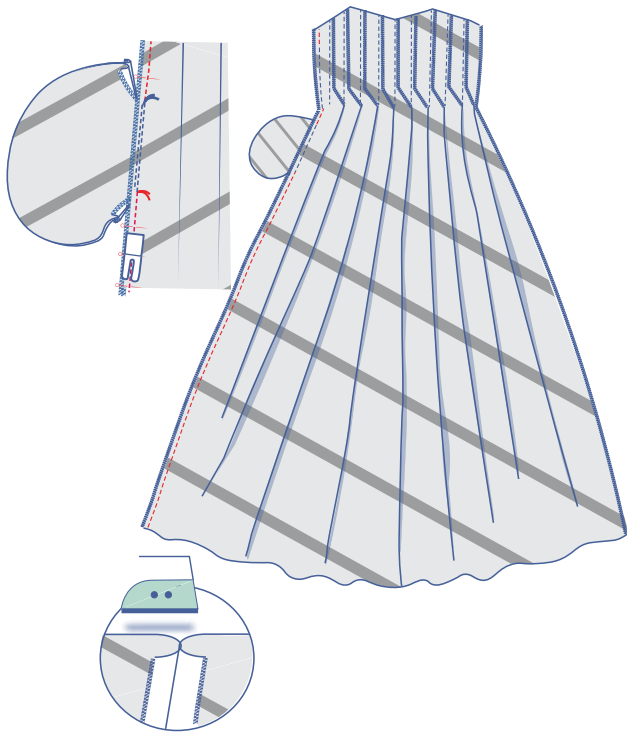

Now, stitch from the next marking thread (the bottom of the pocket opening) down to the hem, making sure you keep the seam allowances of the pocket out of the way. Press the seam allowance open.

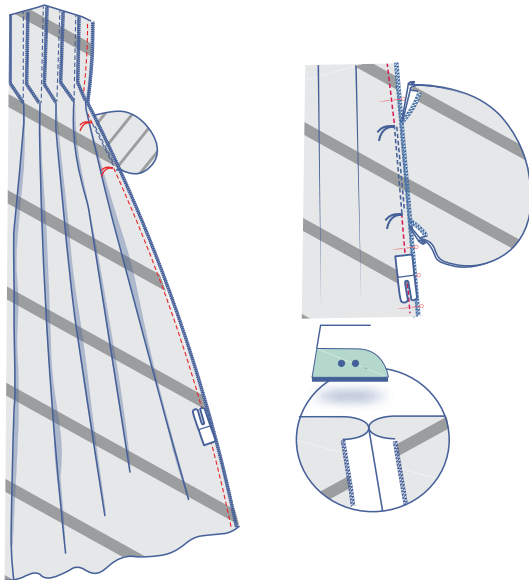

Pin and sew the right side seam right up to the marking thread that marks the top of the pocket. Now, stitch from the next marking thread (the bottom of the pocket opening) down to the hem, making sure you keep the seam allowances of the pocket out of the way. Press the seam allowance open.

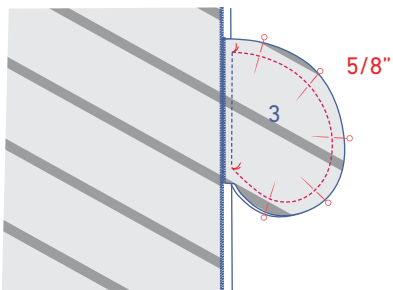

Pin and sew the contours of the pocket pieces together with a 5/8" seam allowance.

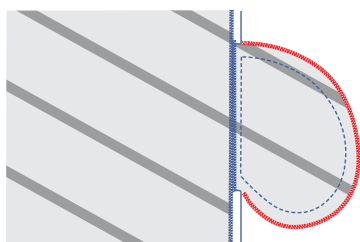

Finish the raw edges with overlock stitching.

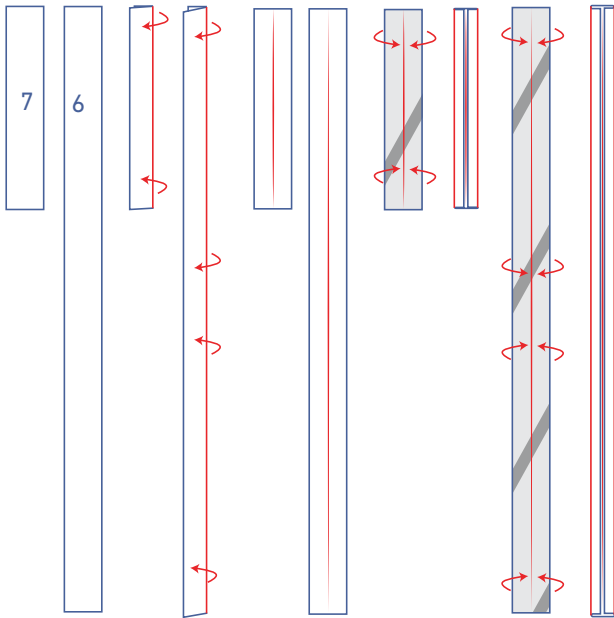

## 6

Press shoulder strap A (6) and shoulder strap B (7) as follows:

- Press the long edges of in half with the wrong sides touching and open back out.
- Press the long ends in to meet the fold line.

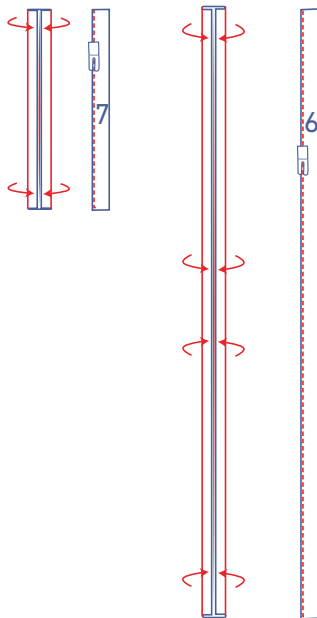

- Fold the long edges in half again, press, and edgestitch into place.

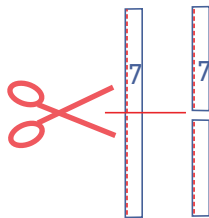

- Cut shoulder strap B down the middle, into two equal parts.

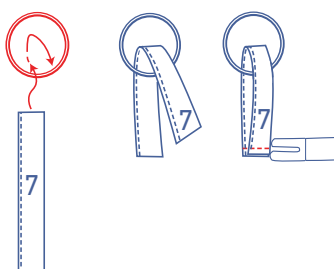

## 7

Thread each of the short shoulder straps through a ring and make a loop. Stitch the ends closed.



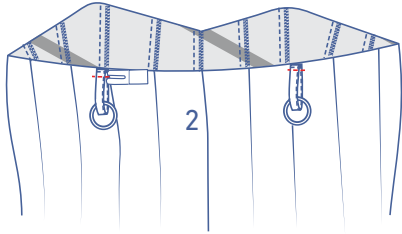

Sew the raw edges of the short straps to the back (right sides together) where indicated at presser foot width from the raw edge.

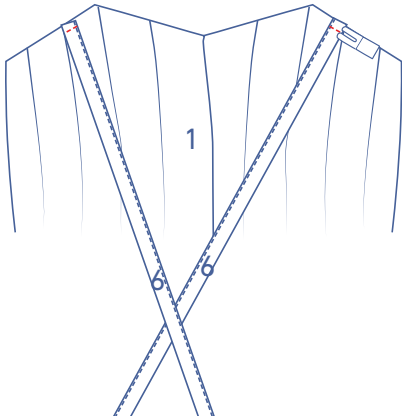

Pin one end of shoulder strap A to the top of the front where indicated. Sew into place at presser foot width from the raw edge.

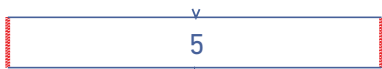

## 8

Finish the sides of the front facing (4) and back facing (5) with overlock stitching.

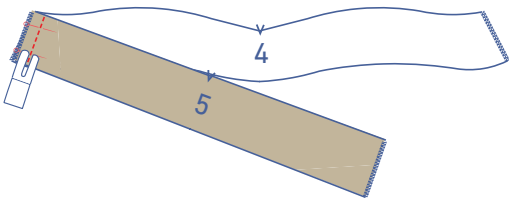

Pin and sew both side seams and press the seam allowance open.

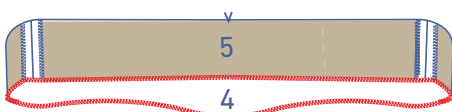
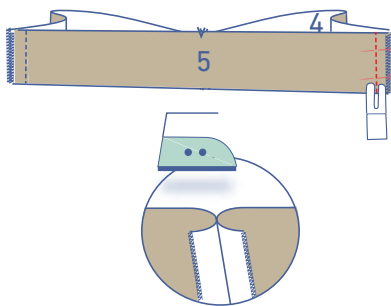

Overlock the bottom of the facing.

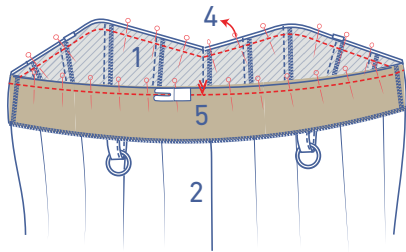

Pin and sew the facing to the top, right sides together, matching the notches and seams.

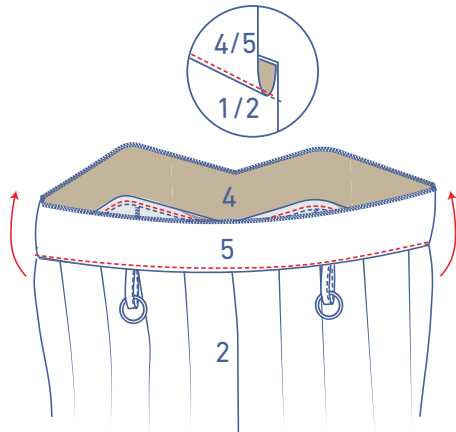

Fold the facing and seam allowance up and sew the facing to the seam allowance underneath, right next to the seam.

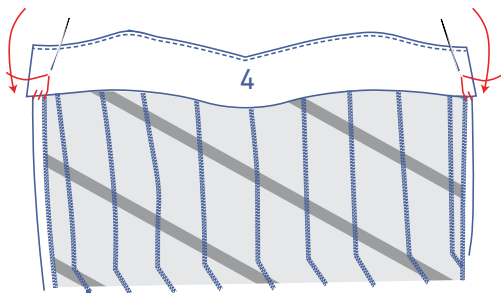

Hand sew or stitch the facing into place along the inside of the side seams with just a few stitches.

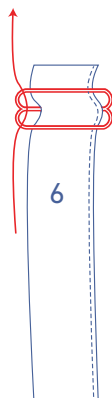

**9**

Thread the end of the long shoulder strap A through the slider from the bottom.

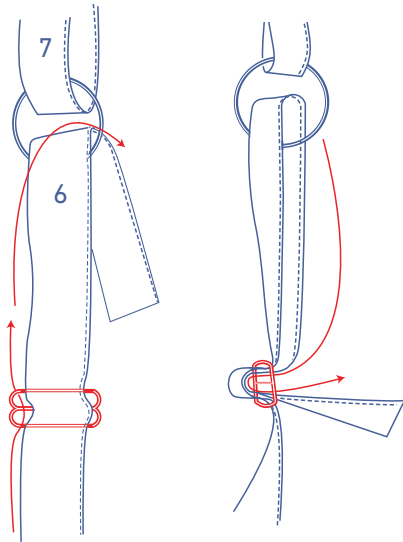

Now, thread it through the ring and fold it back down to thread it through the back of the slider.

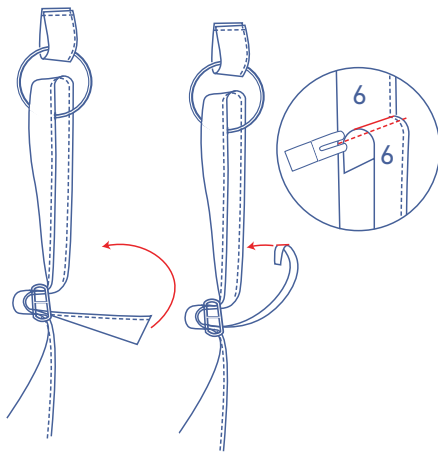

Fold the raw edge over of the strap and sew into place.

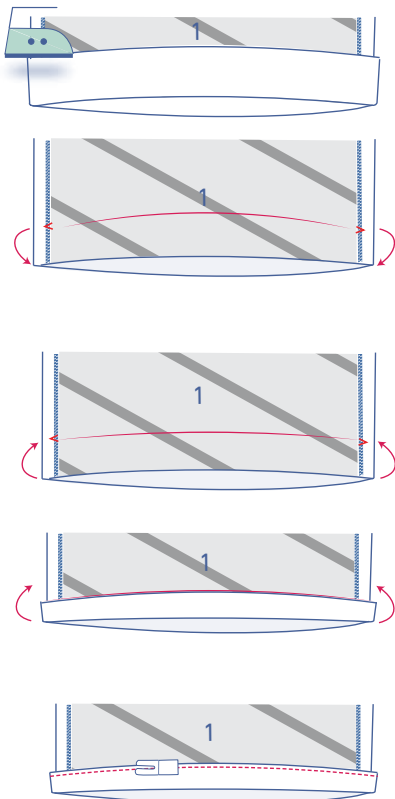

## 10

Press the hem allowance over and open back out.

Match the raw edge to the pressed fold line and fold up again.

Sew into place next to the edge.