

Vikki by Fibre ⚡ood



Vikki by Fibre ood

***✦✦



4 - 32

Wanna bet that this airy maxi dress with its plunging V-neck at the front and back will soon be your new summer favourite? Vikki has details galore – gathered shoulders, a flounce at bust-height, another at the top of the skirt, and horizontal pleats all the way down to the hemline (sure to keep you busy for a while). It's quite the job, but the feeling you get pulling this delightful, swirly dress on? It more than makes up for it.

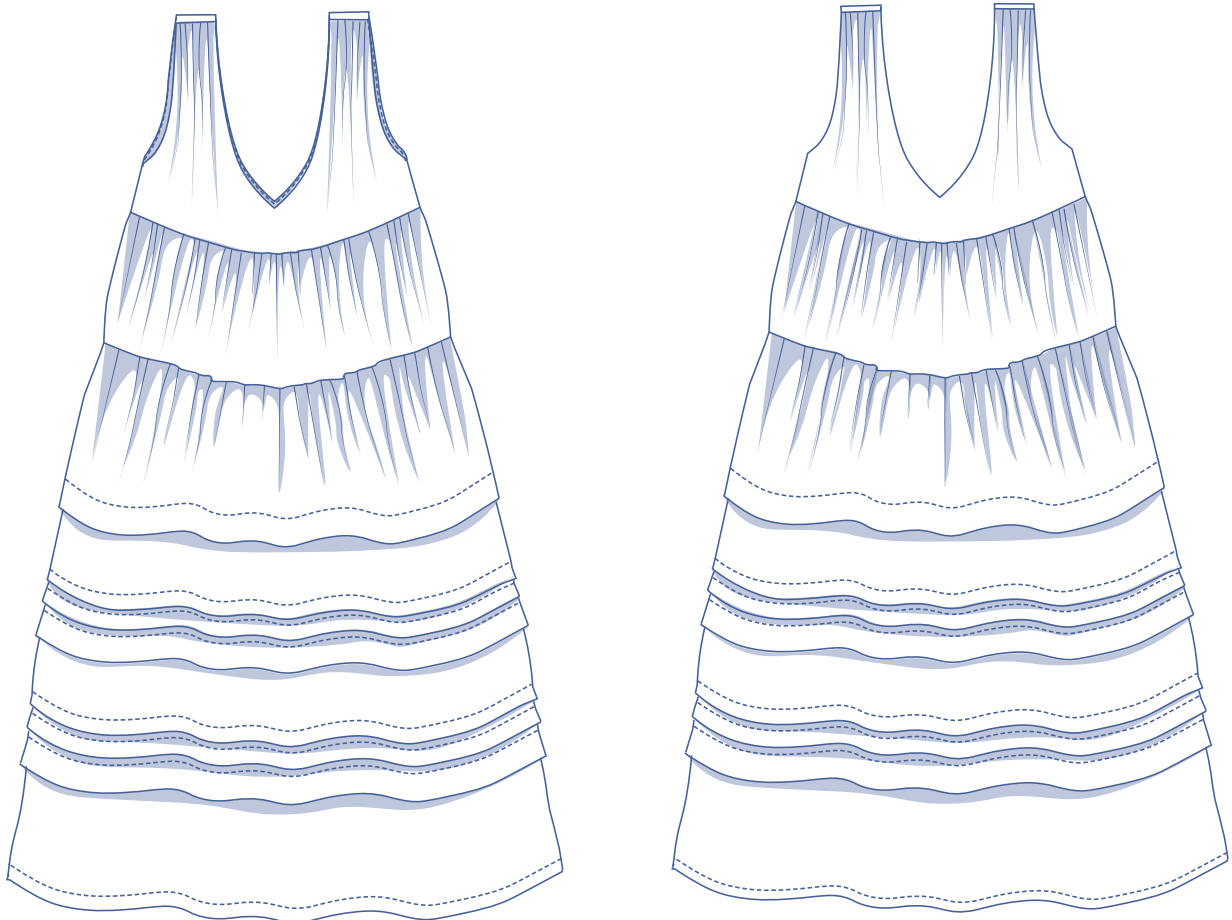

size chart (in cm)

size	4	6	8	10	12	14	16	18	20	22	24	26	28	30	32
body height	160	164	166	167	168	169	170	171	172	172	172	172	172	172	172
B (bust)	76	80	84	88	92	96	100	104	110	116	122	128	134	140	146

Choose your size based on your **bust measurement**. Pick the size that is the best match for your bust.

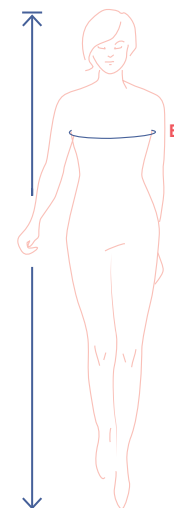

pattern measurements (in cm)

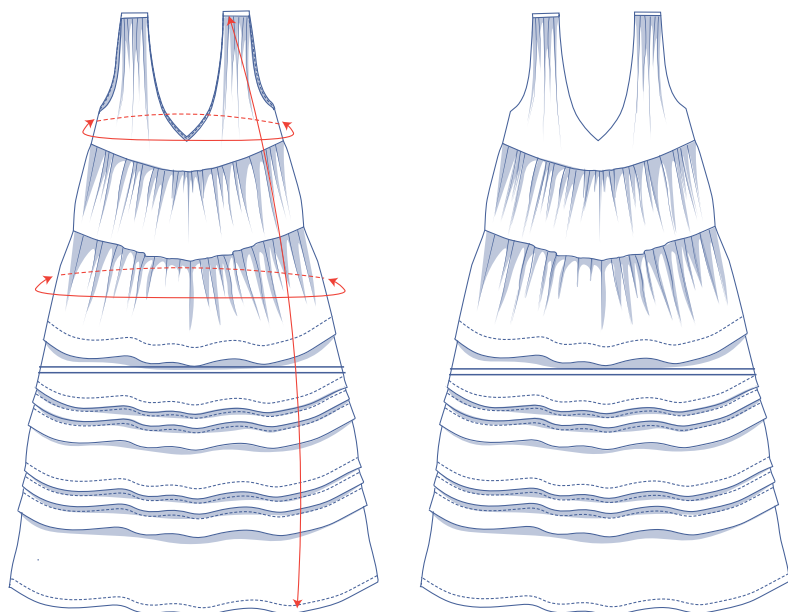

== shorten or lengthen the pattern here

This chart's measurements are the pattern measurements based on the fabric type and serve as a reference. Ease has been added to the width measurements (in addition to the exact body measurements) for a more comfortable fit. Vikki is designed to be **fitted at the bust, with an empire silhouette**.

size	4	6	8	10	12	14	16	18	20	22	24	26	28	30	32
length	135.25	135.75	136.5	137	137.5	138	138.5	139.25	140	140.75	141.5	142.25	143.25	144	144.75
bust	80	84	88.25	92.25	96.25	100.25	104.25	108.25	114.25	120.25	126.5	132.5	138.5	144.5	150.5
hips*	157.5	165.5	173.5	181.5	189.5	197.5	205.5	213.5	225	236.5	248.25	259.75	271.5	283	294.5

* Including ruffle allowance.

Compare the stated lengths to the measured or desired lengths. **Lengthen** or **shorten** the dress by cutting the pattern pieces along the indicated double lines. Then either increase the distance between the cut pieces by the desired amount (to lengthen) or overlap the pieces (to shorten). Make sure that the CF and CB lines and the side seams are always straight.



IMPORTANT

Adjust the amount of fabric to be used based on these alterations.

notions



- Thread
- Iron-on interfacing: max. 90 cm
- Fabric: see table

fabric		4	6	8	10	12	14	16	18	20	22	24	26	28	30	32
fabric width 110 cm	cm	415	415	420	465	470	470	475	475	*	*	*	*	*	*	*
fabric width 140 cm	cm	320	320	395	395	395	395	400	400	400	480	485	485	490	515	530

* Fabric layout not given because pattern pieces 3 and 6 are too large to fit on the given fabric width.

The corresponding fabric layout can be found on page 6 of these sewing instructions.

fabric advice



Suitable options for Vikki include a range of cottons, such as voile, poplin, Broderie Anglaise, chambray, etc. However, more drapery fabrics, such as silk (satin), lyocell, crepe, and double gauze also work well. To really show off Vikki's charms? Go for a solid fabric or a subtle print – pinstripes for example.

Proud to be #Sewista

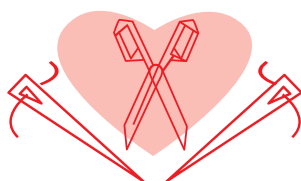

pattern pieces & seam allowances (in cm)

To sew the garment as described in the instructions, draw the illustrated seam allowances around the paper pattern pieces before cutting them out. If you are using a PDF pattern, the pattern can be printed with or without seam allowance.

To find out more, watch the [video](#).

- | | |
|--|------------------------------------|
| 1. front: 1x on fabric fold | 6. skirt back: 1x on fabric fold |
| 2. front piece centre: 1x on fabric fold | 7. shoulder insert: 2x |
| 3. skirt front: 1x on fabric fold | 8. front facing: 1x on fabric fold |
| 4. back: 1x on fabric fold | 9. back facing: 1x on fabric fold |
| 5. back piece centre: 1x on fabric fold | 10. pocket: 4x |

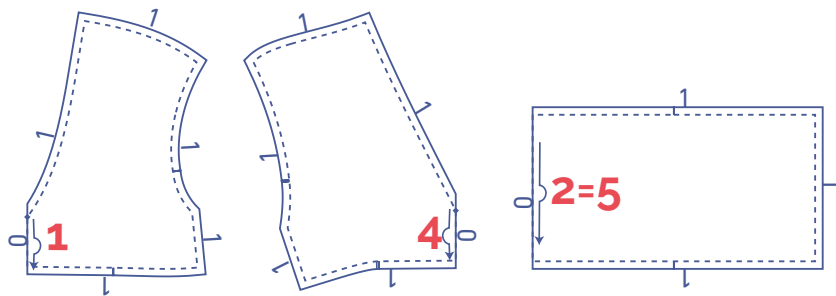

IMPORTANT

Pattern pieces 2 and 5, and 3 and 6 are the same pattern pieces.

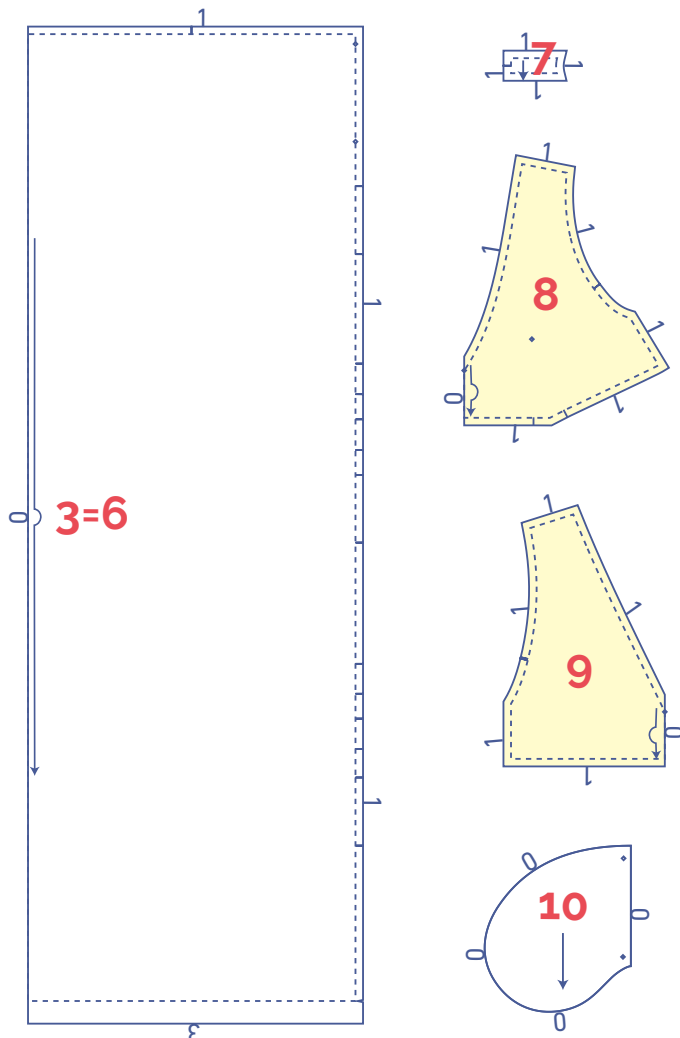

IMPORTANT

The pieces highlighted in light yellow have iron-on interfacing attached to the wrong side.

	material type
	fabric
	iron-on interfacing

fabric layout – solid fabrics
fabric width 110 cm

4 - 8

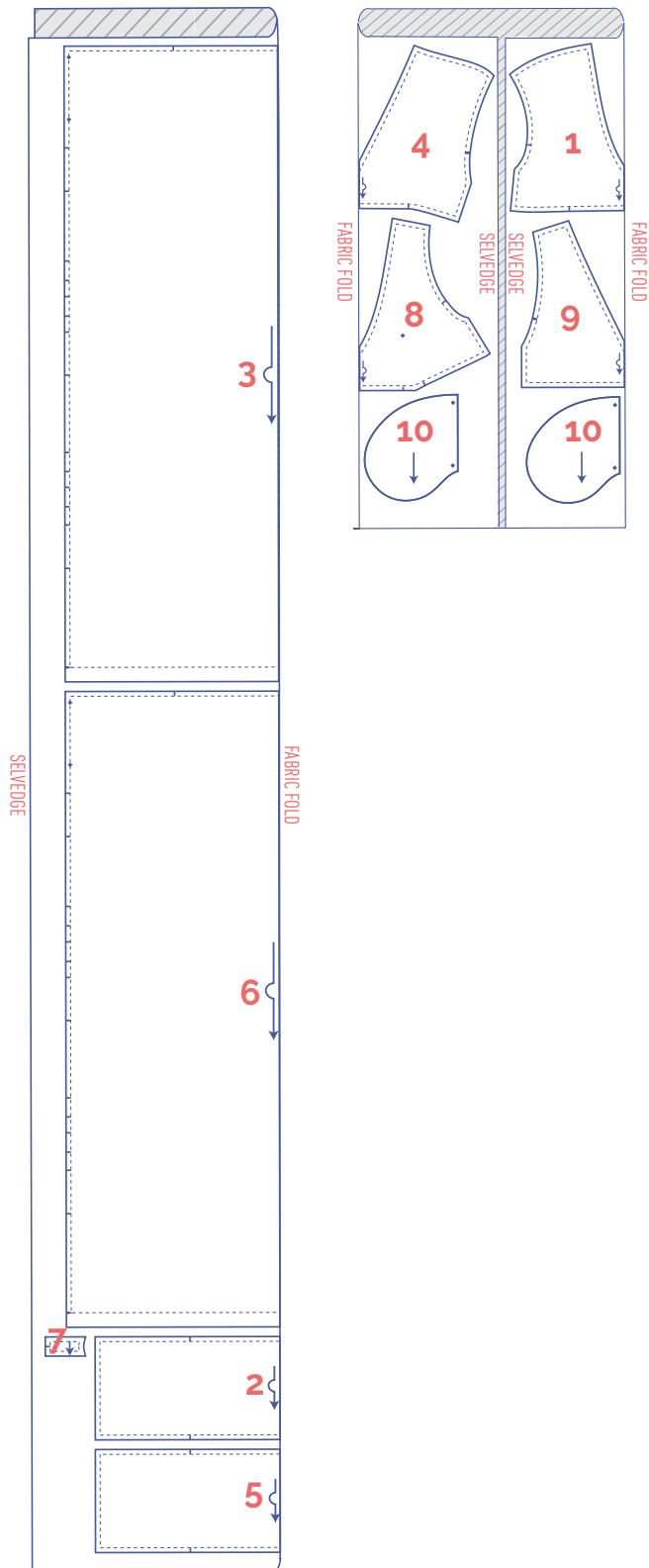

10 - 18

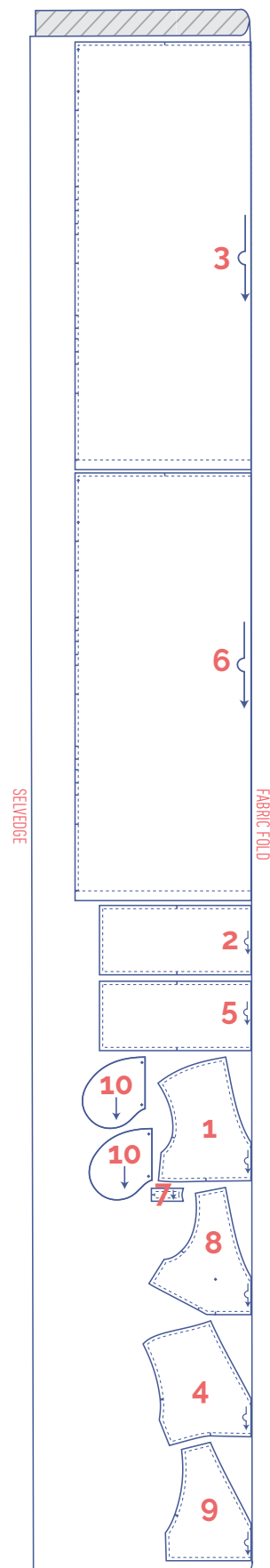

fabric layout – solid fabrics
fabric width 140 cm

4 - 6

8 - 20

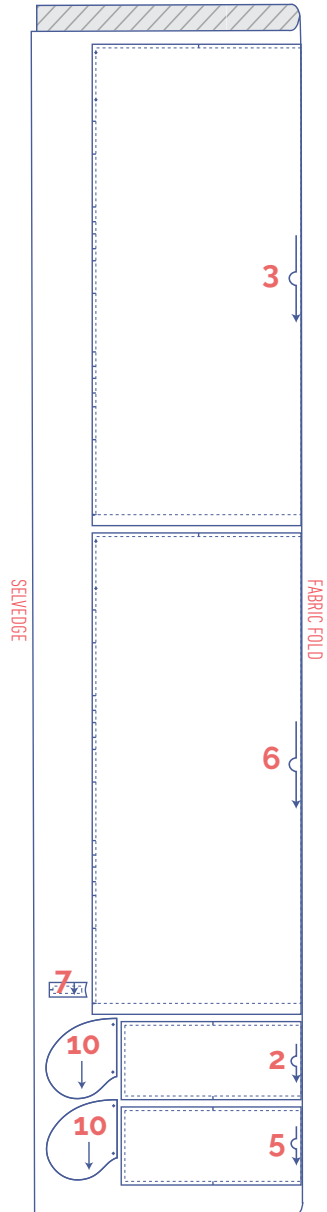
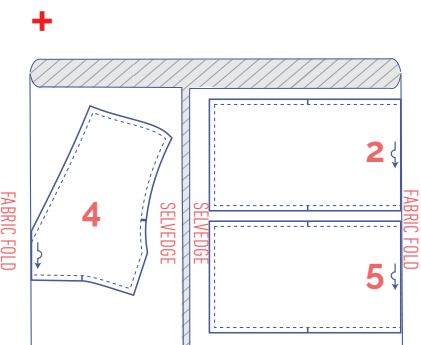
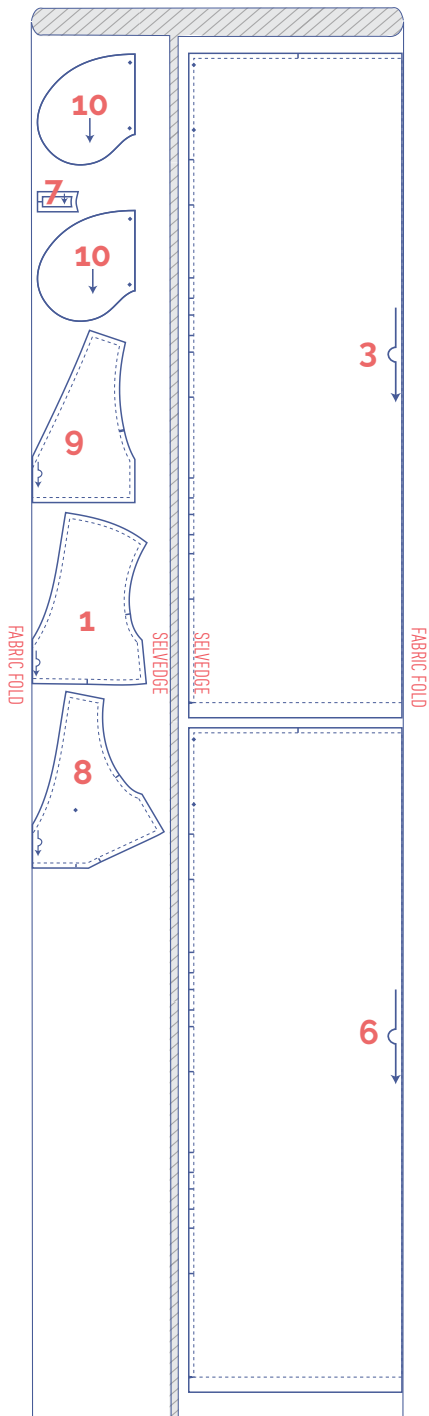

+

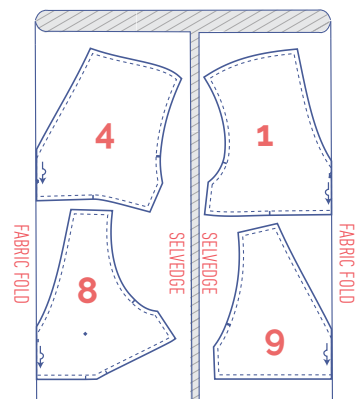

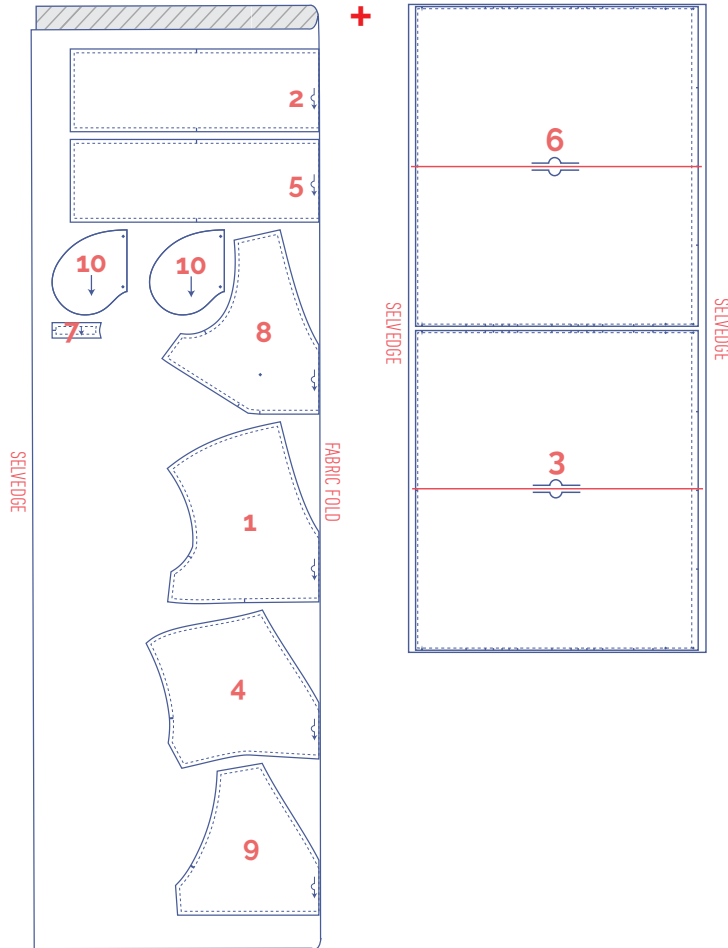
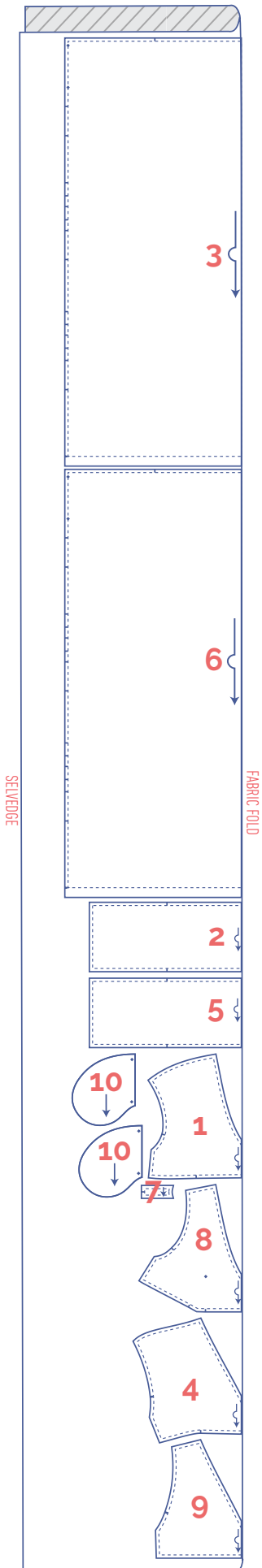

marking pattern pieces

✂	Notch the pattern paper and fabric at the following points	📍	Mark the following points using marking thread
	single notch	📍	centre point
	double notch		
V	V notch		

sewing instructions



The method used to finish the seams depends on the fabric used. The pieces are always sewn together with the right sides of the fabric facing, unless stated otherwise.

F front

B back

CF centre front

CB centre back

 right side

 wrong side

 iron-on interfacing

1

Sew 2 parallel rows of stitching at the top of the front (1), and back (4) using a long stitch length at a low thread tension. Leave a length of thread at the start and end of the stitching.

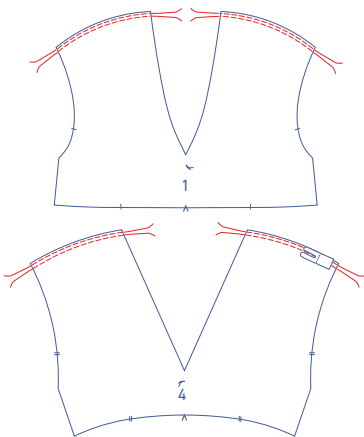

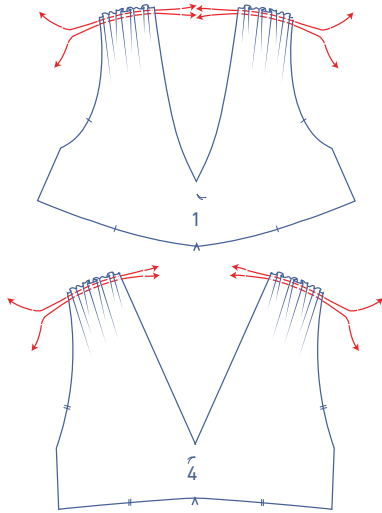

Carefully tug the ends of the threads to gather the fabric into ruffles.

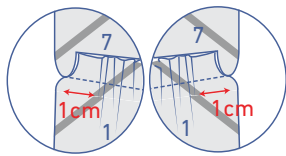

Pin the front to the shoulder insert (7), distributing gathers. Make sure that the 1 cm seam allowance on both sides of the front piece is not gathered. Stitch into place.

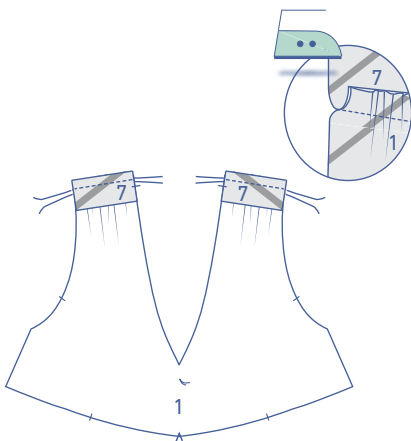
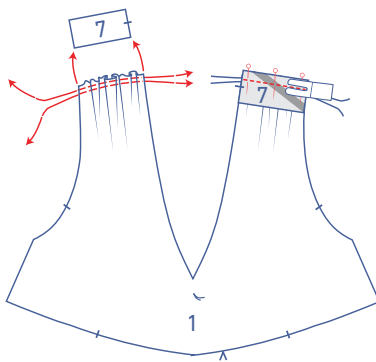

Press the seam allowance towards the insert.

Pin the back to the shoulder insert, distributing gathers. Make sure that the 1 cm seam allowance on both sides of the back piece is not gathered. Stitch into place.

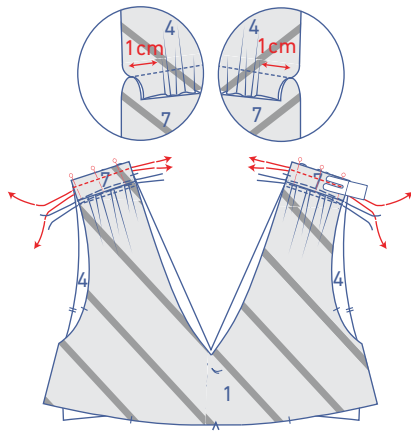

Press the seam allowance towards the insert.

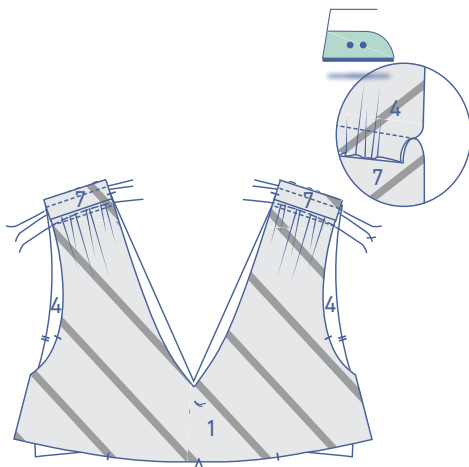

Remove the gathering threads.

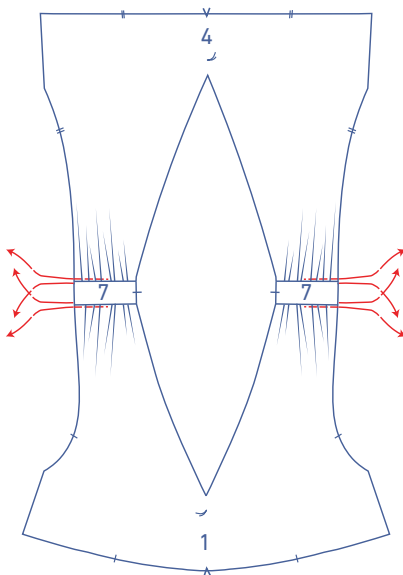

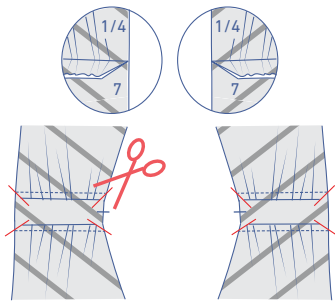

Trim the seam allowance diagonally at the tips to prevent the fabric from bunching.

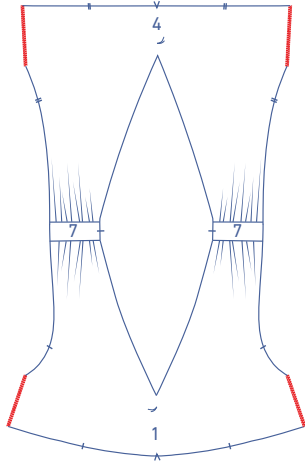

Finish the sides of the front and back with overlock stitching.

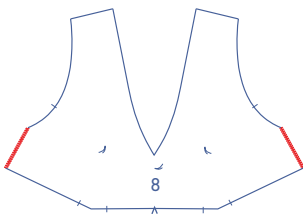

2

Finish the sides of the front facing (8) and back facing (9) with overlock stitching.

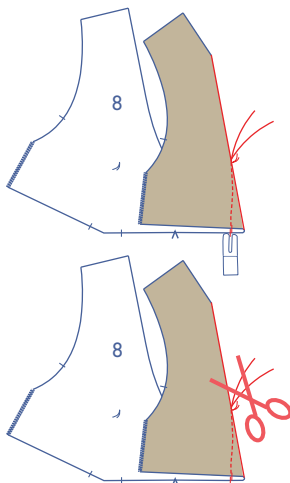
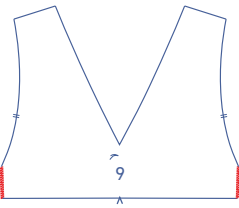

Fold the front facing (8) right sides together, matching notches at the bottom. Sew the dart in a slightly curved line towards the marking thread. Stitch up to and just past the marking thread, so that you've sewn past the fabric. Snip the threads and make a knot.

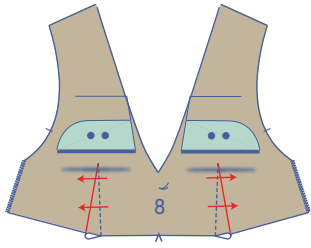

Turn the front facing over so that the wrong side is facing up. Press the dart allowance towards the side.

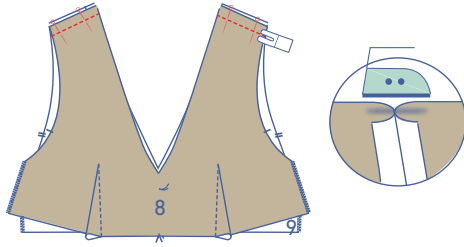

Pin and stitch the shoulder seams of the facing pieces. Press the seam allowances open.

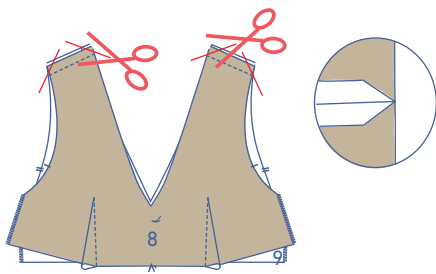

Trim the seam allowance diagonally at the tips to prevent the fabric from bunching.

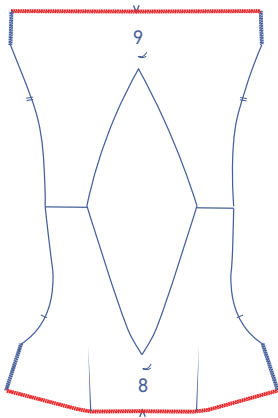

Finish the indicated edges of the facing with overlock stitching.

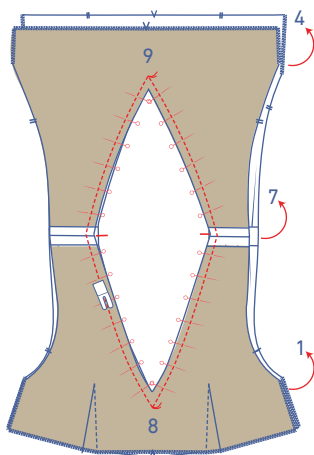

3

Pin and sew the necklines of the facing and the top piece together. Sew parallel to the edge of the neckline opening up to the marking threads as shown.

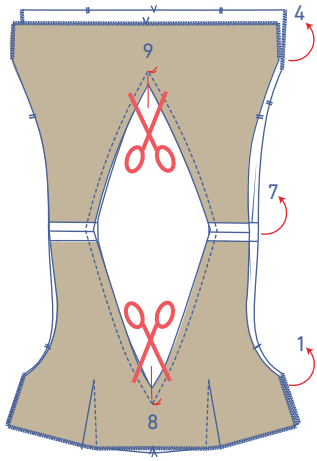

Snip into the seam allowance at the V on both front and back until just before the marking thread.

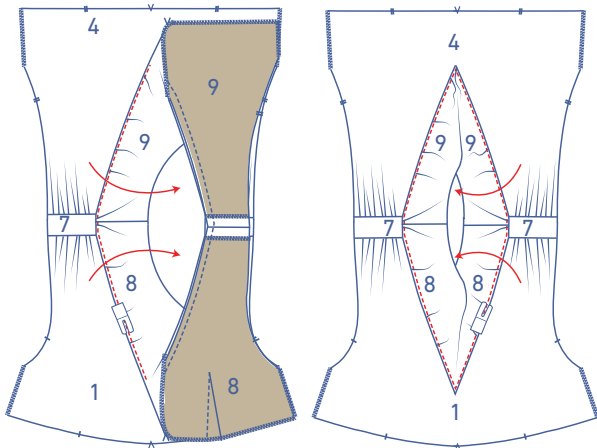

Fold the facing and seam allowance over and sew the facing to the seam allowance underneath, right next to the seam.

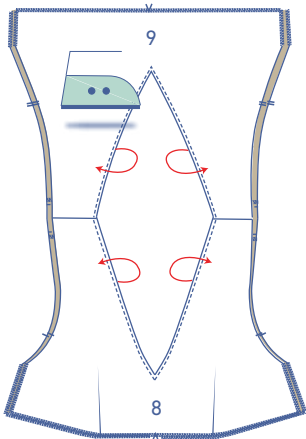

Fold the facing towards the wrong side and press flat.

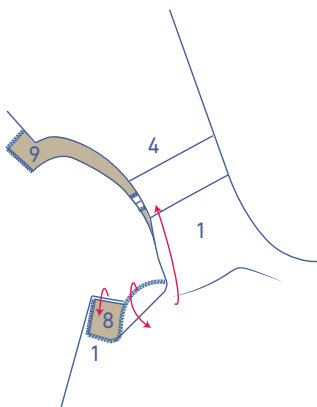

Now, fold the front back facing over onto the front top piece armhole so the right sides of the fabric are touching. Line up the raw edges of the armhole evenly.

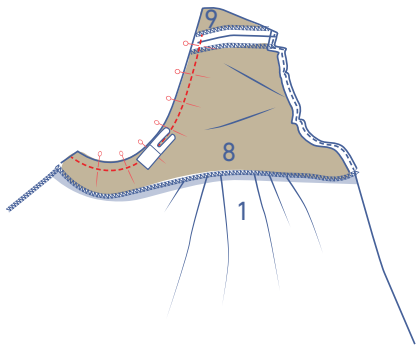

Stitch the facing to the top piece together, starting from the side. Stitch section by section, i.e. match the raw edges and sew approximately 2 cm. Match the next section of raw edges and sew another section, etc. Continue until you've sewn just past the shoulder seam.

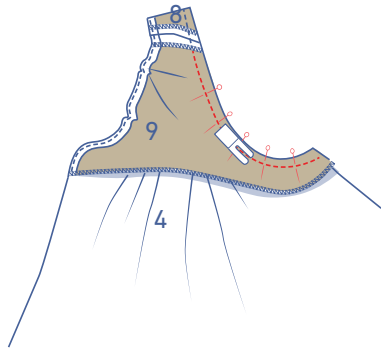

Now, repeat for the back armhole. Stitch the back facing to the back top piece and sew from the shoulder (starting from where you just stopped stitching) to the side.

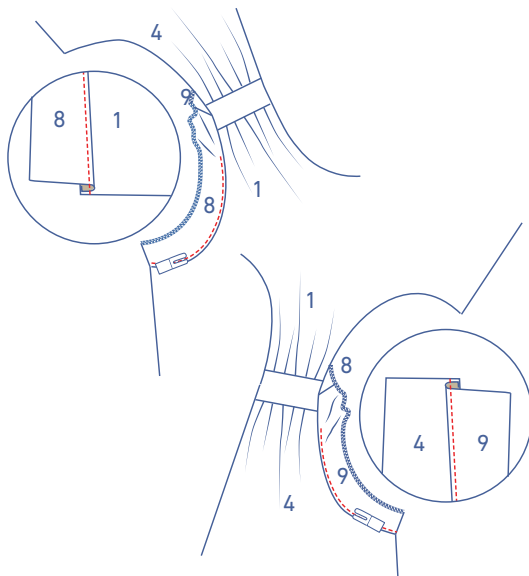

Fold the facing over and stitch it to the seam allowance underneath, right next to the seam. Sew as far as you can. Stop stitching and start again down the other side of the armhole. This may seem like a lot of fiddling, but have faith. You're on the right track as long as you follow these instructions.

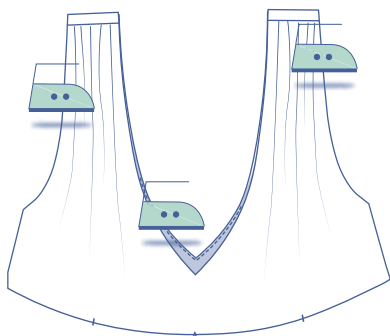

Tuck the facings back under the top piece. Steam the top piece.

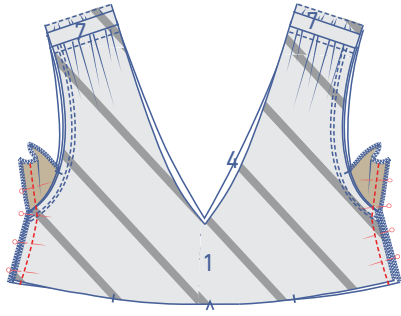

Pin and sew the side seams of the top piece and facing. Please note: the facing pieces should be folded up when you do this.

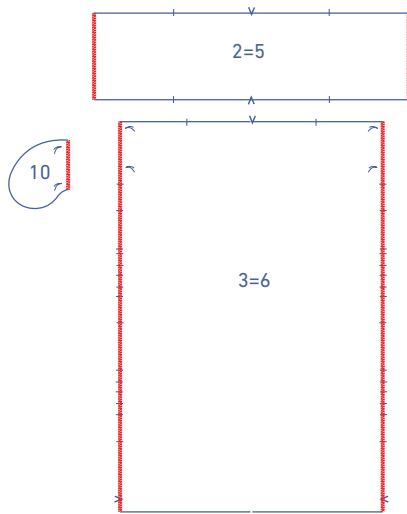

4

Finish the sides of the front piece centre (2), back piece centre (5), skirt front (3), and skirt back (6), and the straight ends of the pocket (10) with overlock stitching.

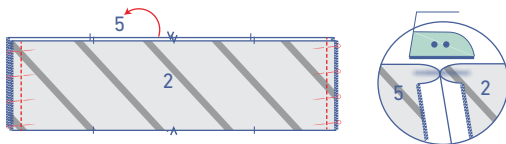

Pin and sew the side seams of the centre panel (pieces 2 and 5) and press the seam allowance open.

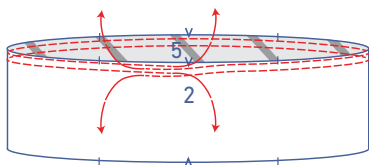

Use a long stitch at a low thread tension to sew 2 parallel rows of stitching to the top of the centre panel. Leave a length of thread at the start and end of the stitching.

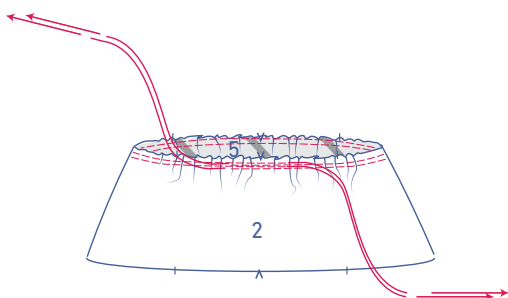

Carefully tug the ends of the threads to create gathers in the fabric.

Distribute the gathers until the centre panel notches match those at the bottom of the front and back.

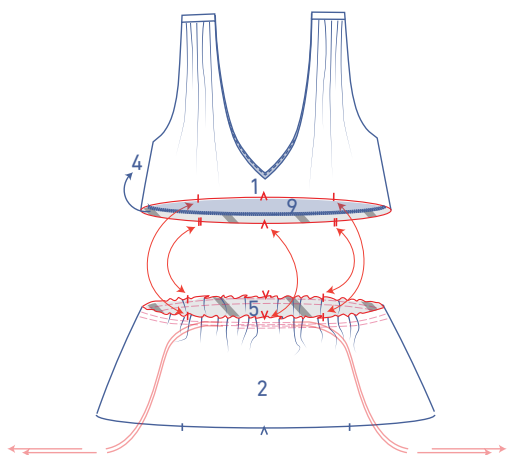

Slide the centre panel over the top pieces, right sides together. Pin and sew the centre panel to the bottom of the front and back (pieces 1 and 4). Make sure you only sew the front and back (pieces 1 and 4) and not the facing (pieces 8 and 9).

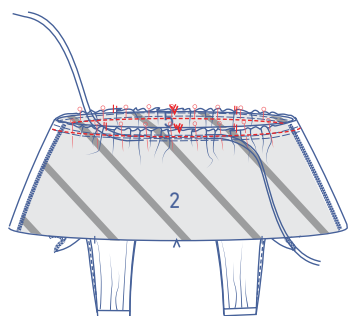

Finish the raw edges with overlock stitching. Press the seam allowance towards the top.

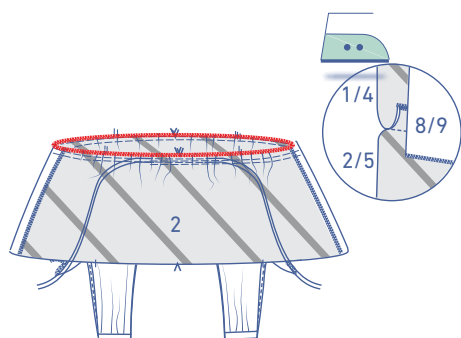

Remove the gathering threads.

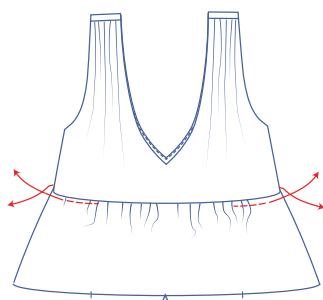

Sew the facing into place by hand with a few stitches along the side seam.

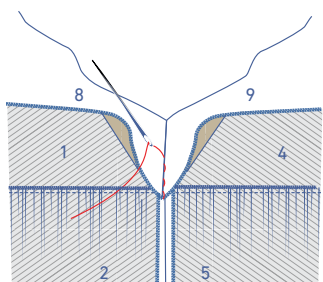

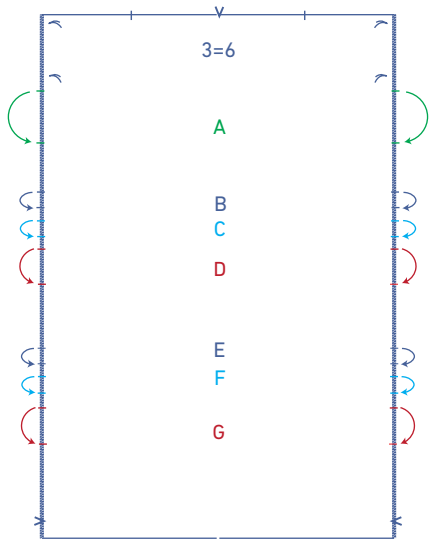

5

Match the notches in the skirt front (3) and skirt back (6) pieces as shown.

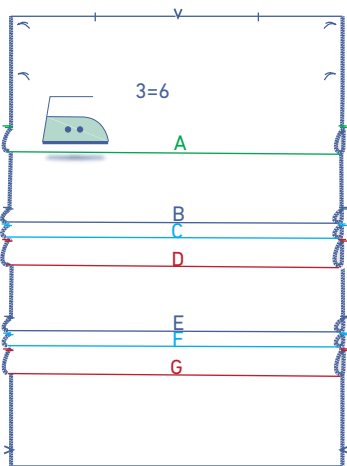

Now, press the pleats on the skirt pieces towards the bottom of the skirt, with the wrong sides of the fabric facing.

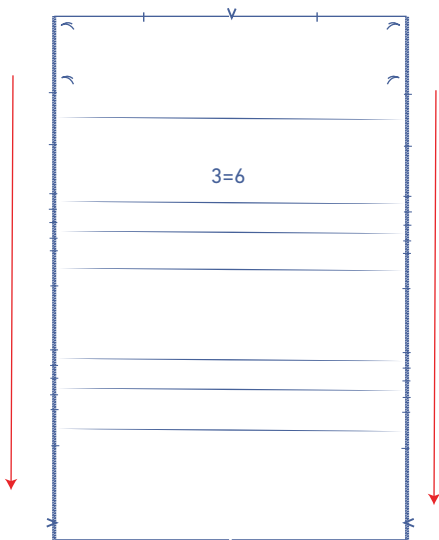

Open back out.



Pin the straight end of the pocket pieces to skirt pieces 3 and 6, matching the marking threads. Sew into place between the marking threads.

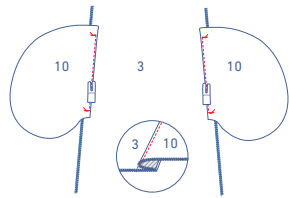

Fold over the pocket attached to the skirt front (3) and stitch the pocket to the seam allowance underneath. Please note: do not do this for the pocket pieces attached to the back skirt.

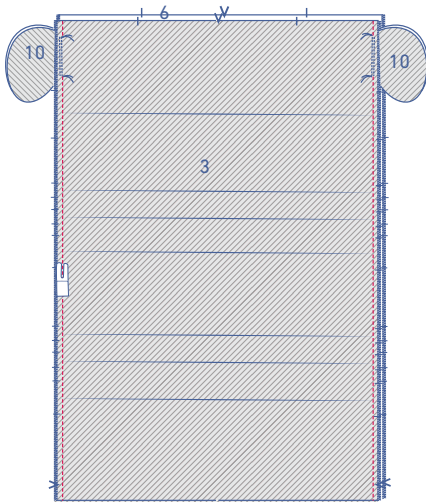
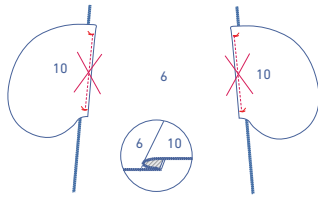

Pin and sew the side seams of the skirt front and skirt back when they are completely flat (= no folds!), matching the notches and fold lines.

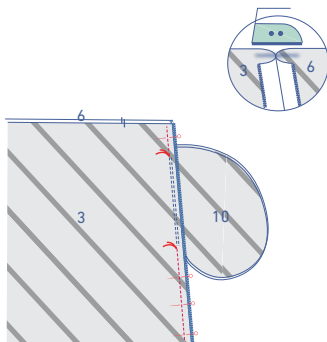

Sew from the top of the skirt until the marking thread that marks the top of the pocket opening. Continue stitching from the next marking thread up to the hem. Press the seam allowance open.

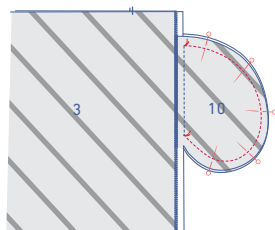

Pin and sew the contours of the pocket pieces together where indicated.

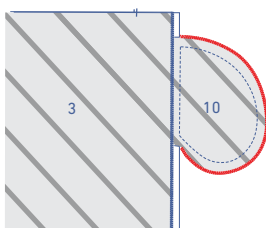

Finish the raw edges with overlock stitching.

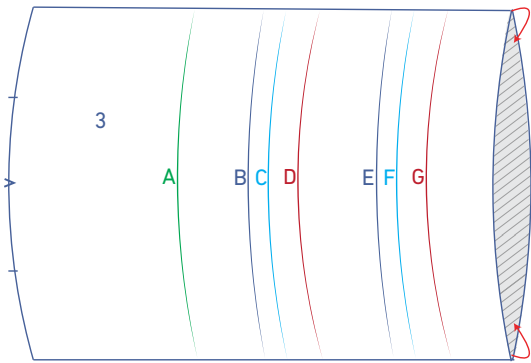

6

Sew the pleats into place all the way around according to the measurements provided below.

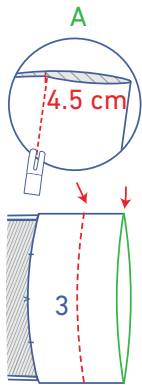

Pleat A: 4.5 cm

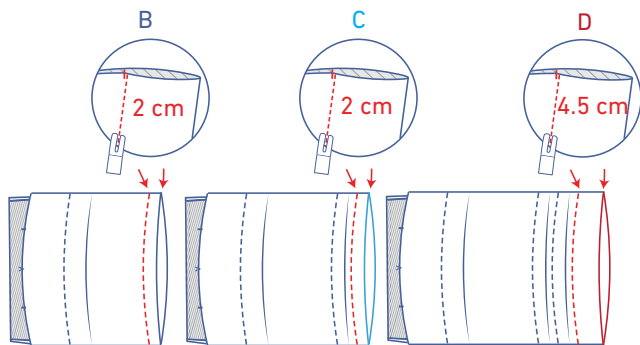

Pleat B: 2 cm
 Pleat C: 2 cm
 Pleat D: 4.5 cm

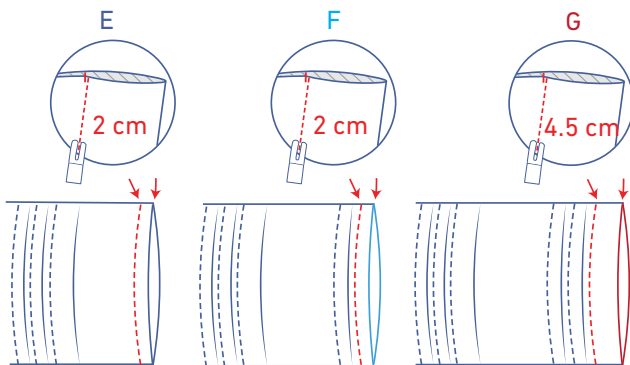

Pleat E: 2 cm
 Pleat F: 2 cm
 Pleat G: 4.5 cm

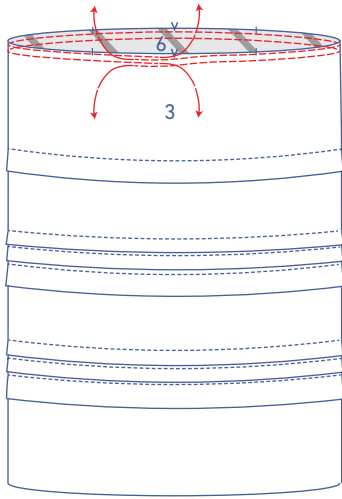

7

Use a long stitch at a low thread tension to sew 2 parallel rows of stitching at the top of the skirt. Leave a length of thread at the start and end of the stitching.

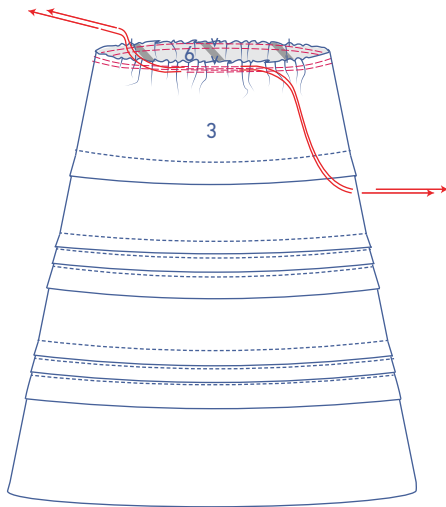

Carefully tug the ends of the threads to create gathers in the fabric.

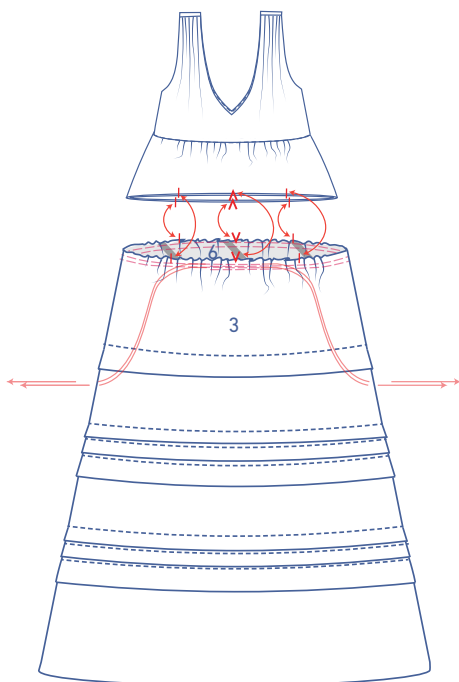

Distribute the gathers until the skirt notches match the notches in the bottom of the centre panel.

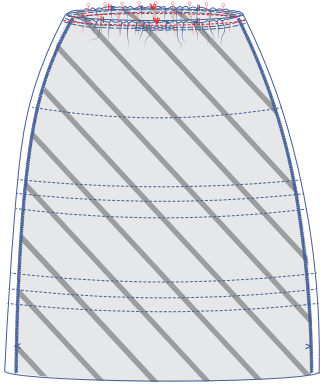

Pin and sew the skirt to the centre panel.

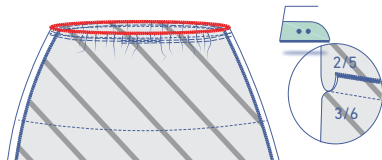

Finish the raw edges with overlock stitching and press the seam allowance towards the centre panel.

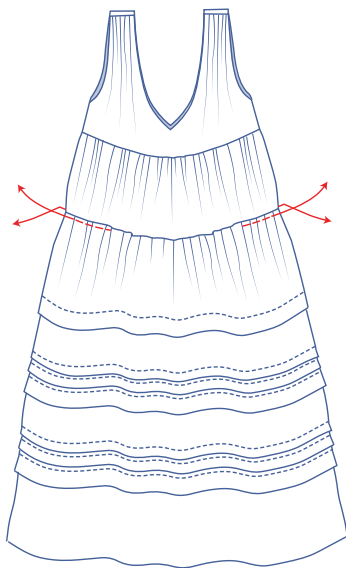

Remove the gathering threads.

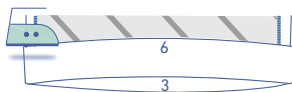

8

Press the hem allowance over at the V notches.

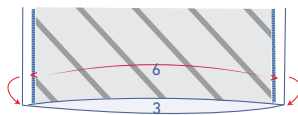

Open back out.

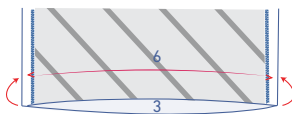

Match the raw edge to the pressed fold line and fold up again.

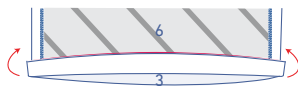

Edge stitch into place.

