

# Chloe by Fibre ⚡ood



# Chloe by Fibre ood

\*\*\*✂✂



4 - 32

Breeze into the warm temperatures of summer in Chloe. Be prepared for all the admiration when you wear this flowing, asymmetrical, off-the-shoulder top. Want to make a Chloe even more of a statement top? Be sure to sew the bow on the shoulder. If you love dressed with plenty of swish you can do that too. Just lengthen it - midi or maxi, maybe a ruffle or two and you'll be ready to conquer summer in style!

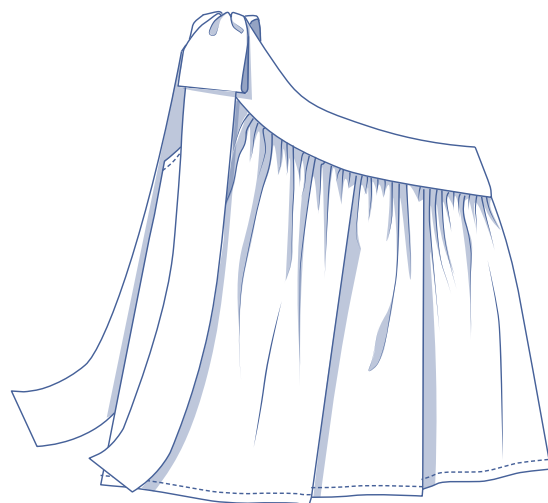
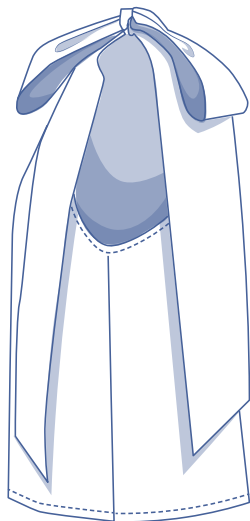
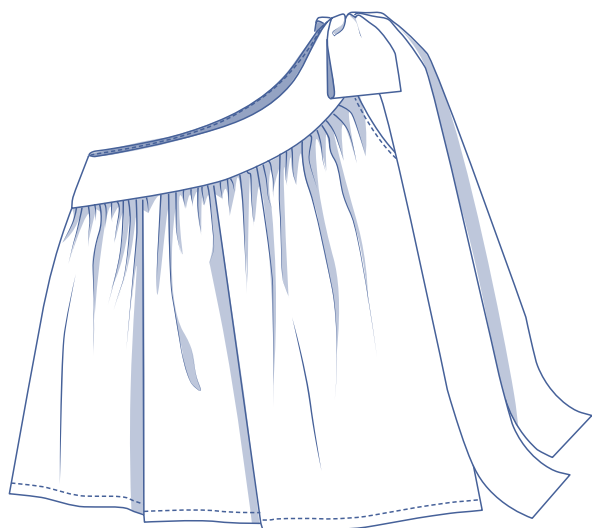

## size chart (in cm)

size	4	6	8	10	12	14	16	18	20	22	24	26	28	30	32
body height	160	164	166	167	168	169	170	171	172	172	172	172	172	172	172
B (bust)	76	80	84	88	92	96	100	104	110	116	122	128	134	140	146

Choose your size based on your **bust measurement**. Pick the size that is the best match for your bust.

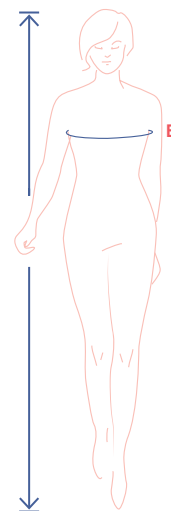

## pattern measurements (in cm)

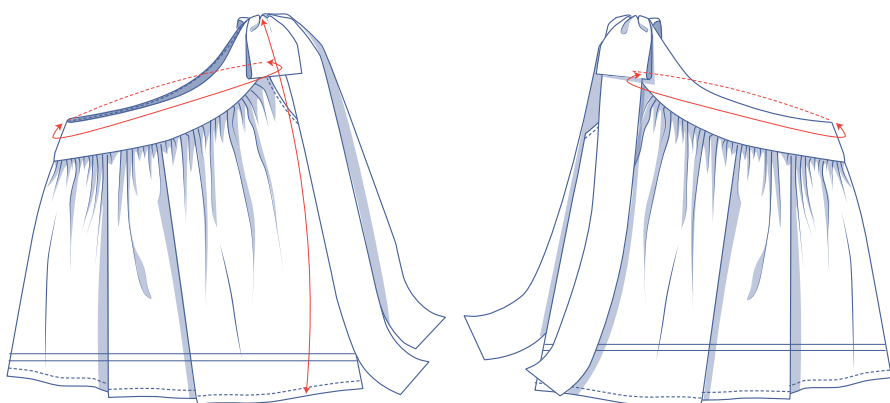

This chart's measurements are the pattern measurements based on the fabric type and serve as a reference. Ease has been added to the width measurements (on top of the exact body measurements) for a more comfortable fit. Chloe is designed to be **(= fitted at the trim and hang loose around the bust)**.

==== shorten or lengthen the pattern here

size	4	6	8	10	12	14	16	18	20	22	24	26	28	30	32
length	58.75	59.5	60	60.75	61.5	62	62.75	63.5	64.25	65	66	66.75	67.5	68.25	69
upper bust*	69.75	73.25	77	80.5	84.25	87.75	91.5	95	100.75	106.5	112.25	118	123.75	129.75	135.5

\* This measurement is only a reference. This covers the length above the bust (measured at an angle) as well as part of the circumference under your armpits.

Compare the stated lengths to the measured or desired lengths. **Lengthen** or **shorten** the top by cutting the pattern pieces at the indicated double lines. Then either increase the distance between the cut pieces by the desired amount (to lengthen) or overlap the pieces (to shorten). Make sure that the CF and CB lines and the side seams are always straight.



### IMPORTANT

Adjust the amount of fabric to be used based on these alterations.

## notions

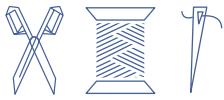

- Thread
- Iron-on interfacing: max. 80 cm
- Fabric: see table

fabric		4	6	8	10	12	14	16	18	20	22	24	26	28	30	32
fabric width 110 cm	cm	195	195	195	195	195	195	195	195	195	240	290	295	300	300	300
fabric width 140 cm	cm	195	195	195	195	195	195	195	195	195	195	195	195	195	195	200

The corresponding fabric layout can be found on page 6 of these sewing instructions.

## fabric advice



Chloe works best in a woven fabric. If you want the top to turn out soft and swishy, select a fabric with a fluid drape (e.g. silk satin, double gauze, viscose crepe, or muslin). A more structured fabric such as poplin or batiste will result in a more statement top.

# Proud to be #Sewista

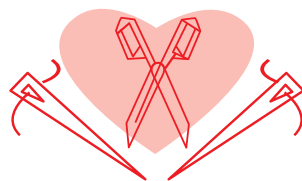

## pattern pieces & seam allowances (in cm)

To sew the garment as described in the instructions, draw the illustrated seam allowances around the paper pattern pieces before cutting them out. If you are using a PDF pattern, the pattern can be printed with or without seam allowance.

To find out more, watch the [video](#).

- |                    |                           |
|--------------------|---------------------------|
| 1. front: 1x       | 4. back trim: 2x          |
| 2. back: 1x        | 5. tie: 1x on fabric fold |
| 3. front trim : 2x | 6. bias tape: 1x          |

**IMPORTANT**

The pieces highlighted in light yellow have iron-on interfacing attached to the wrong side.

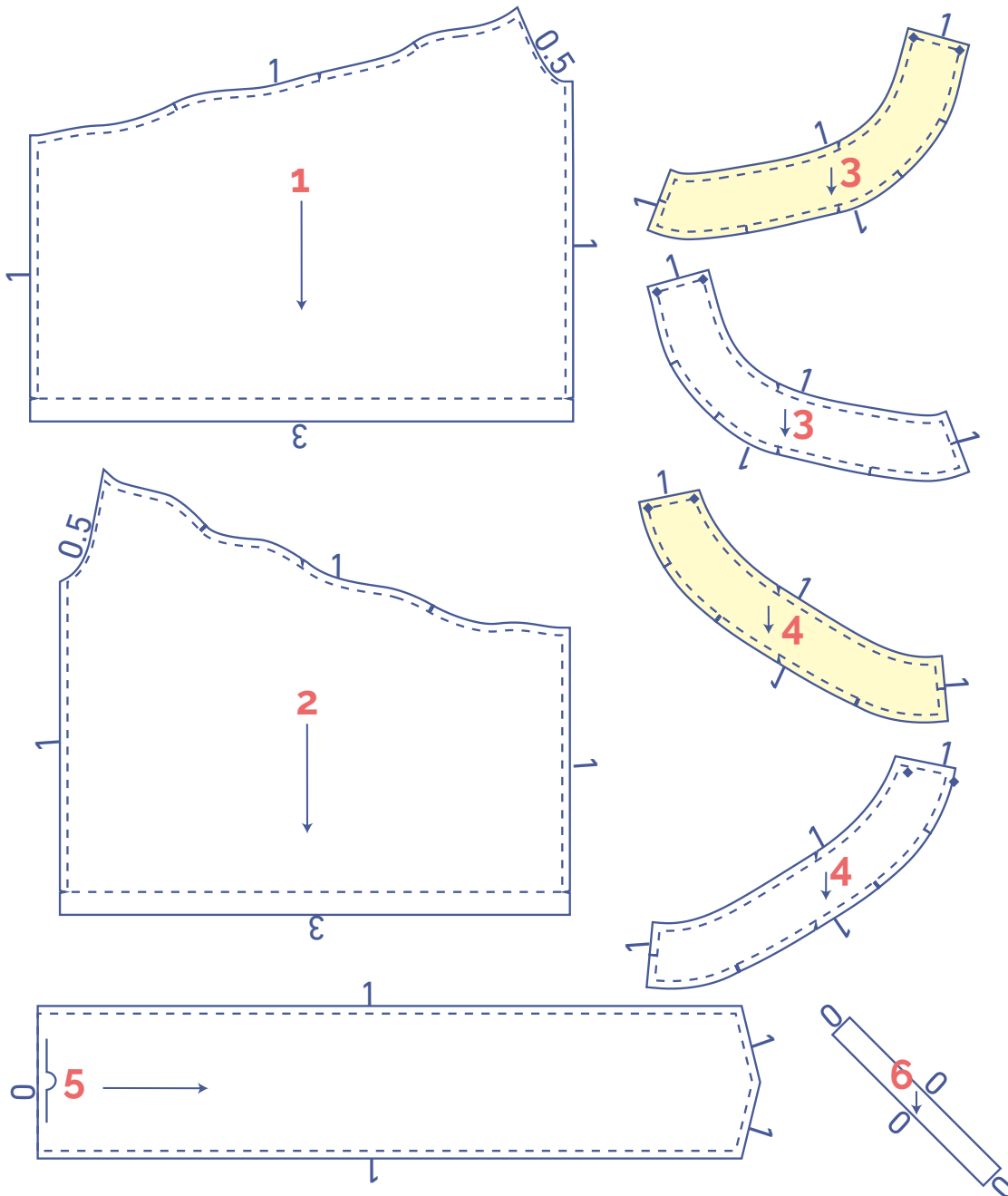

?	material type
	fabric
	iron-on interfacing

**fabric layout – solid fabrics**  
**fabric width 110 cm**

4 - 20

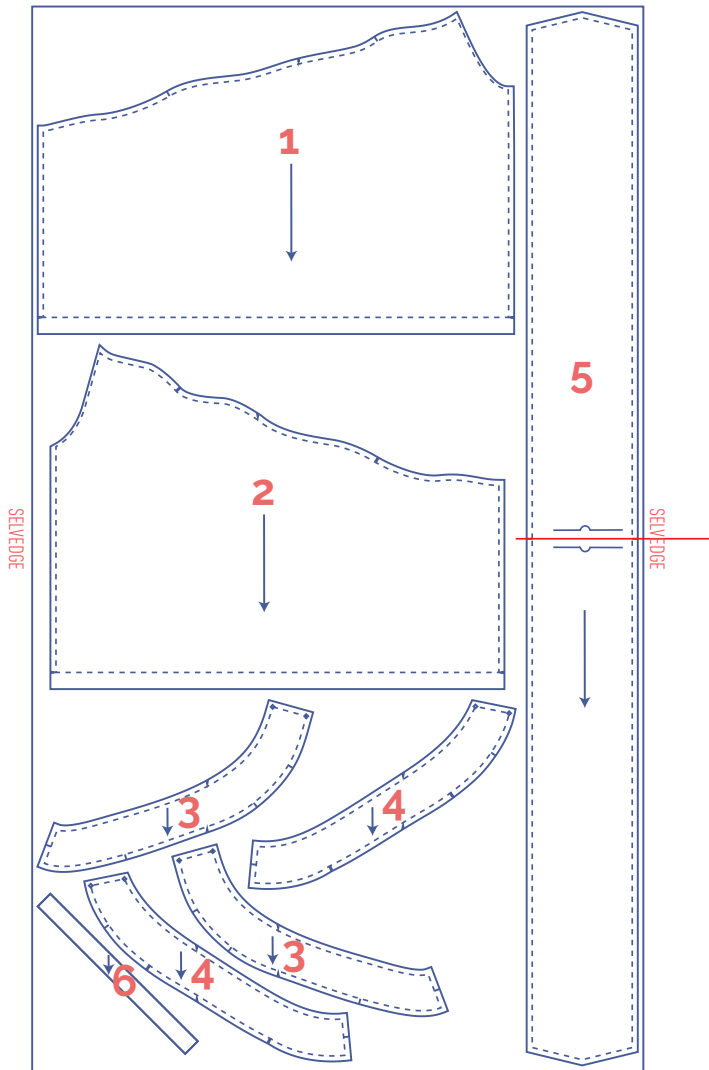

22 - 32

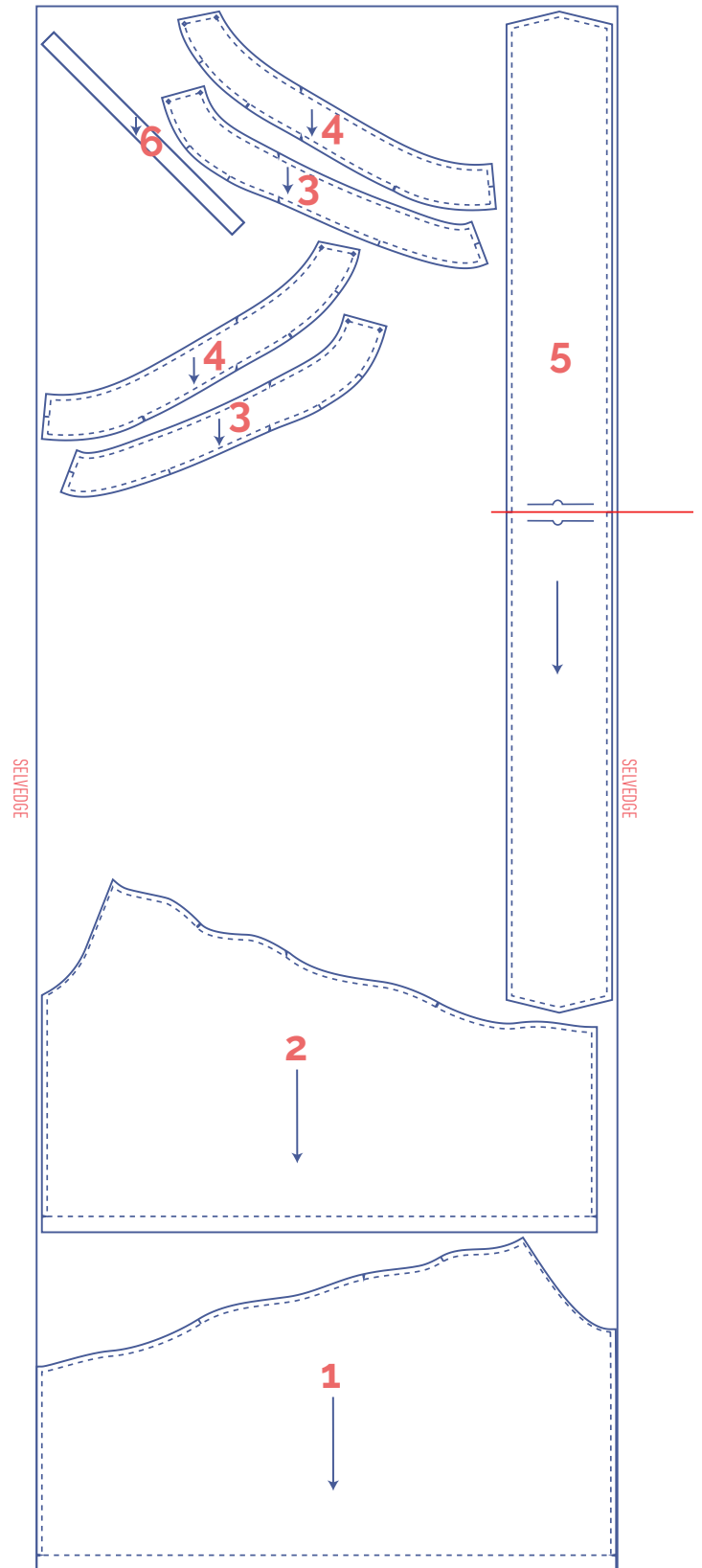

## fabric layout – solid fabrics

fabric width 140 cm

4 - 32

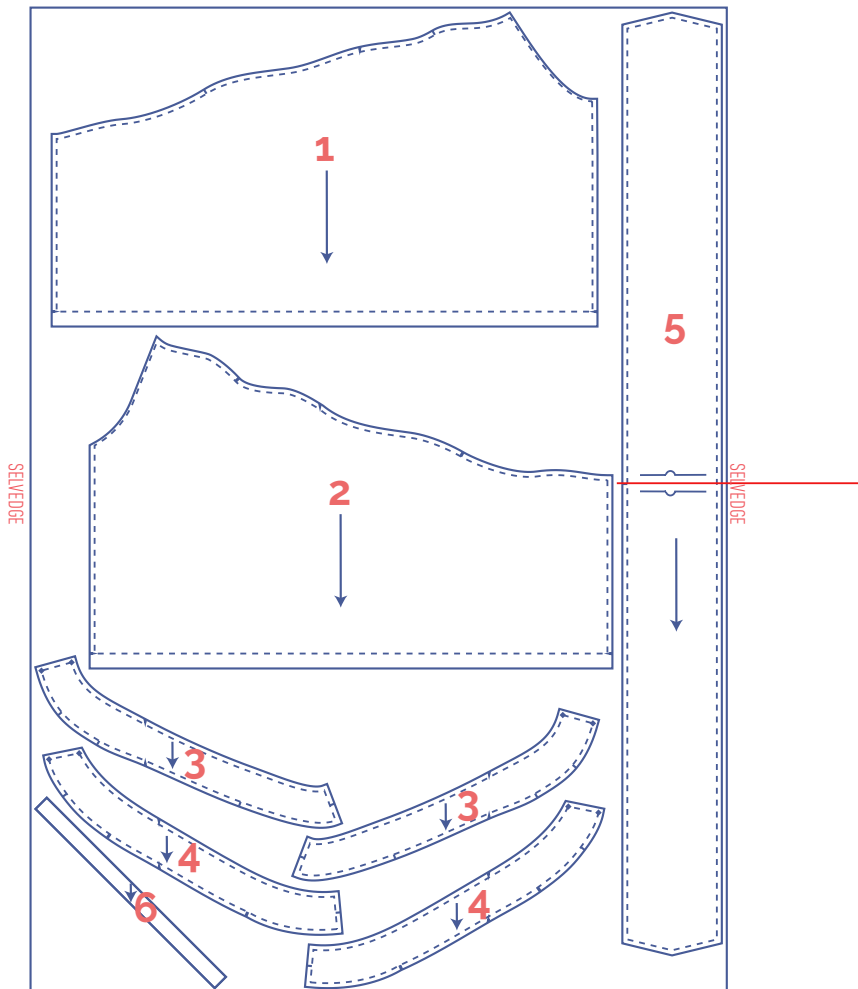

## marking pattern pieces

✂	Notch the pattern paper and fabric at the following points	🧵	Mark the following points using marking thread
	single notch	⤴	centre point
	double notch		
∨	V notch		

# sewing instructions



The method used to finish the seams depends on the fabric used.  
The pieces are always sewn together with the right sides of the fabric facing, unless stated otherwise.



F	front
B	back
CF	centre front
CB	centre back
	right side
	wrong side
	iron-on interfacing

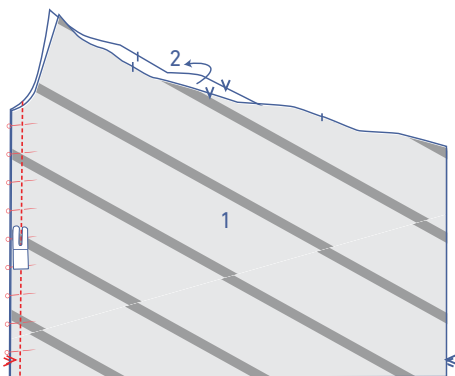
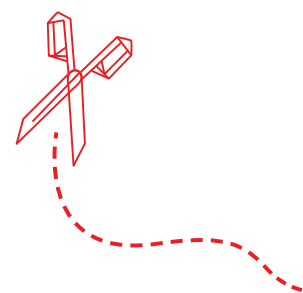

## 1

Pin and sew the sides of the F (1) and B (2) pieces, where indicated.



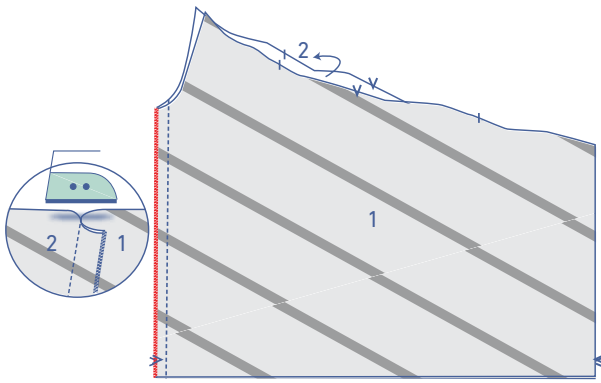

Finish the raw edges together with overlock stitching and press the seam allowance towards the front.

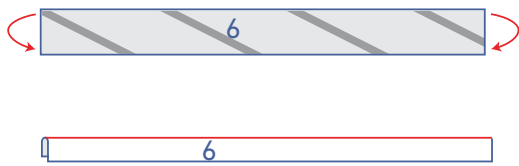

Press the short ends of the bias tape (6) in half with the wrong sides of the fabric facing.

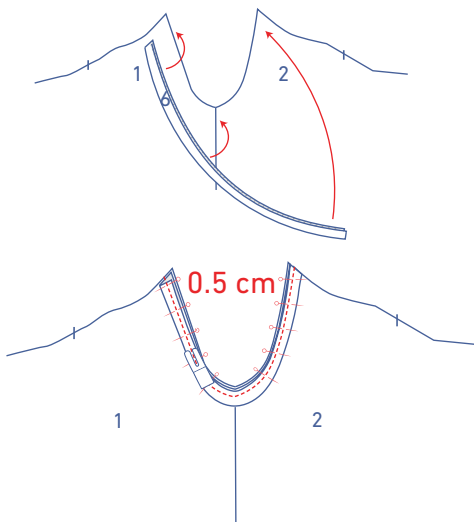

Pin both raw edges of the bias tape to the right side of the armhole.

Stitch into place with a 0.5 cm seam allowance.

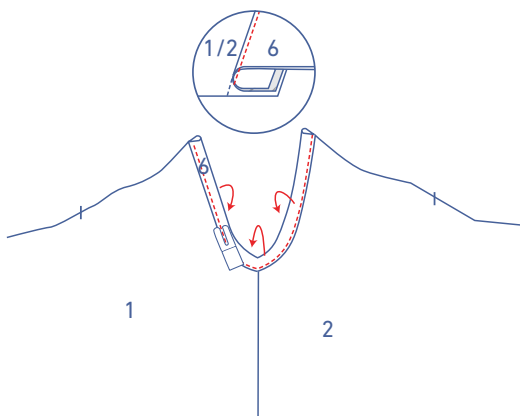

Fold the bias tape over and stitch the bias tape to the seam allowance underneath, right next to the seam.

Press the bias tape all the way over to the wrong side.

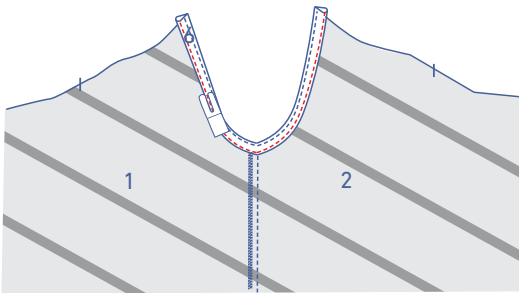
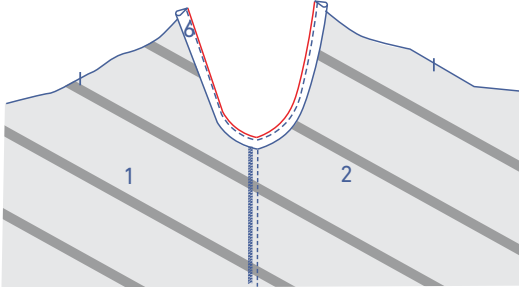
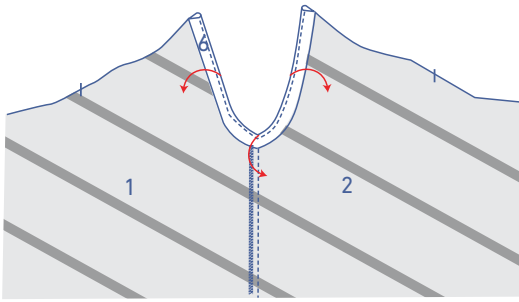

Stitch into place right next to the edge.

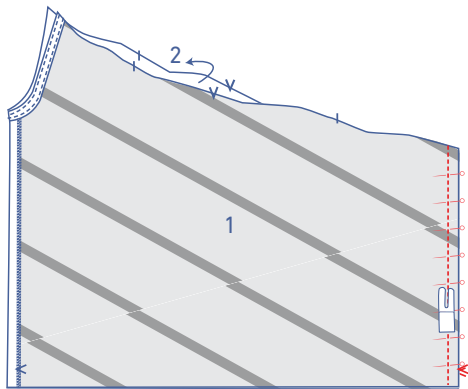

Pin and sew the other side seam into place.

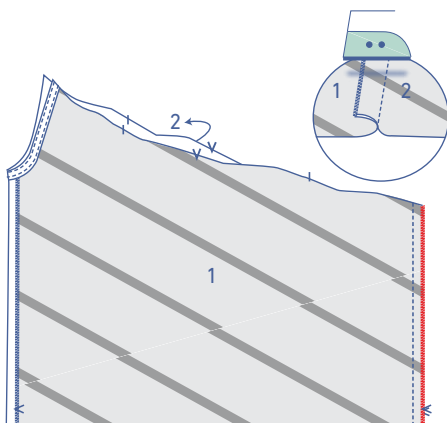

Finish the raw edges together with overlock stitching and press the seam allowance towards the CF.

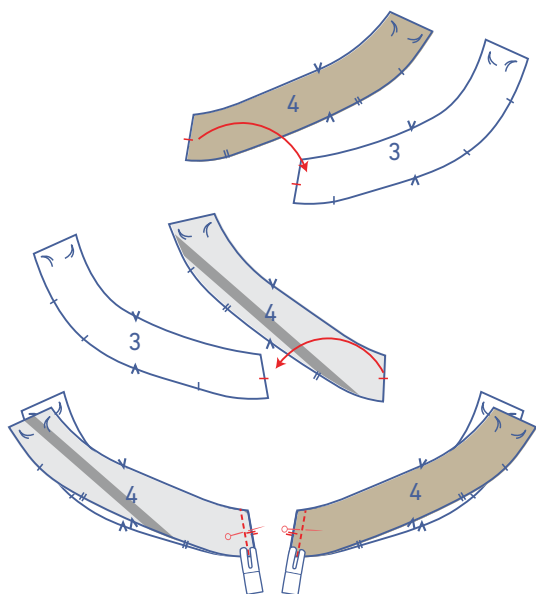

## 2

Make two pieces of trim (piece 3 + piece 4), one that is interfaced and one that is not.

Pin and stitch each notched end of the front trim (3) and back trim (4) together.

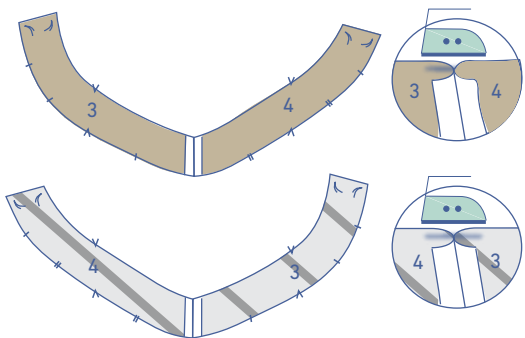

Press the seam allowance open.

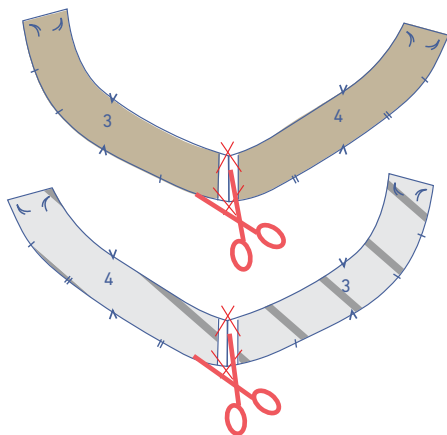

Trim the tips at an angle to prevent the fabric from bunching.

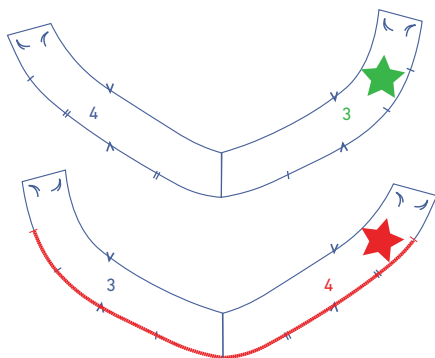

Turn the 2 trim pieces over so that the wrong sides are facing down.

The trim with piece 3 on the right and piece 4 on the left (i.e. the trim that will be on the outside of the top) is marked with a green star.

The trim with piece 4 on the right and piece 3 on the left (i.e. the trim that will be on the inside of the top) is marked with a red star.

Overlock the bottom of the red star trim between the single notches.

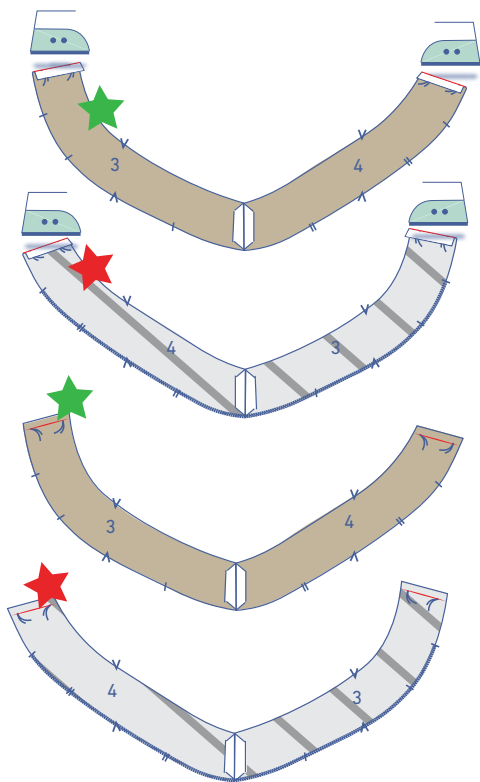

Press each of the short ends with marking threads (i.e., the shoulders) 1 cm over towards the wrong side and then open back out.

### 3

Sew 2 parallel rows of stitching at the top of the garment, using a long stitch length at a low thread tension. Leave a length of thread at the start and end of the rows.

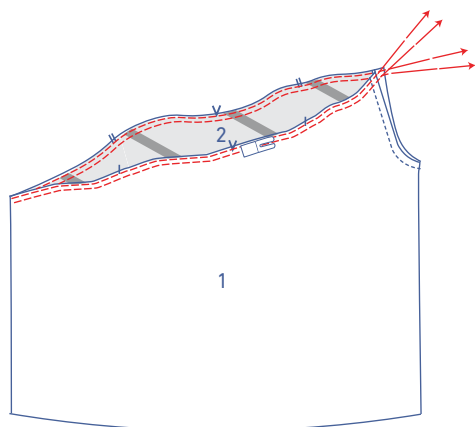

Carefully tug the ends of the threads to gather the fabric.

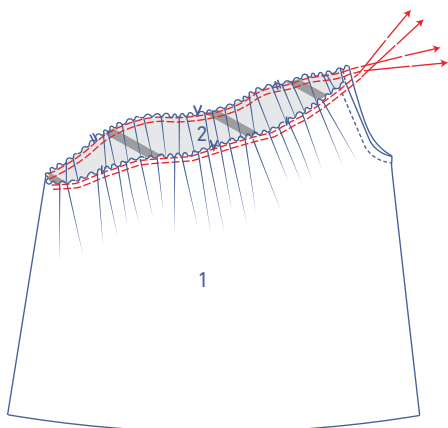

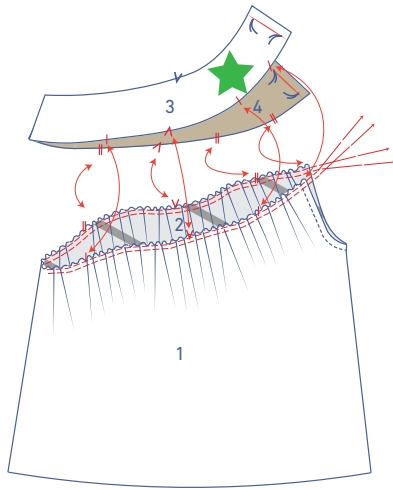

Pin the bottom of the green star trim to the top of the garment, right sides together. Distribute the gathers until the notches match. The outermost single notches is the trim mark where the finished armholes will be.

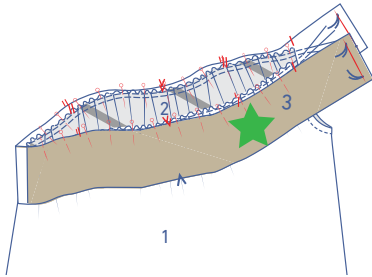

Stitch into place.

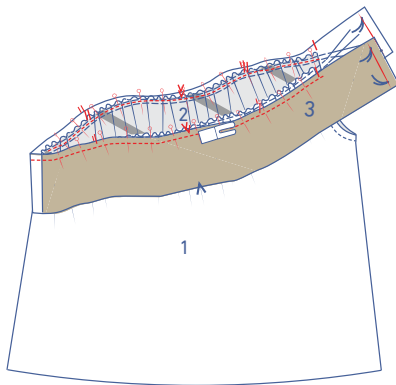

Fold the trim back up.

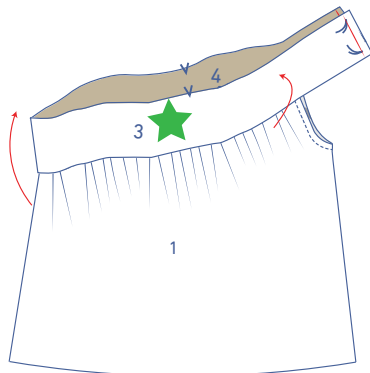

Pin the top of the red star trim to the green star trim, right sides together. Sew into place between the marking threads at the top.

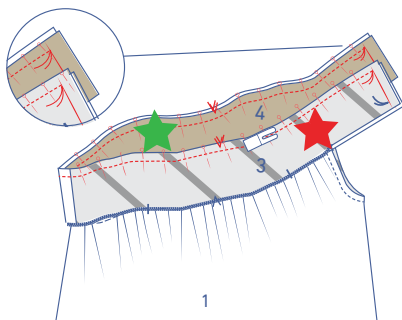

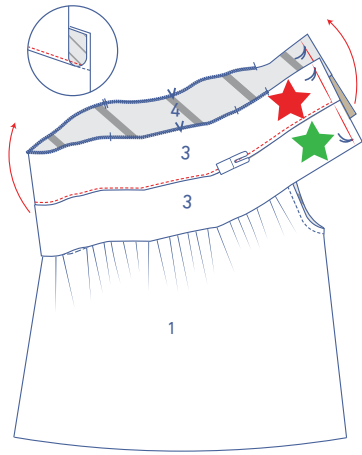

Open the red star trim and stitch the trim to the seam allowance underneath.

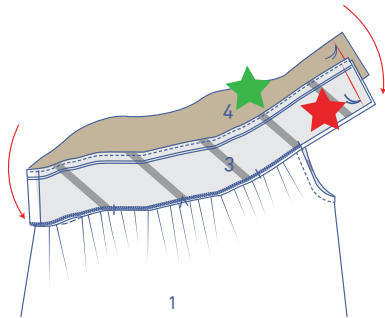

Fold the red star trim back down so that the right sides of the trim are facing.

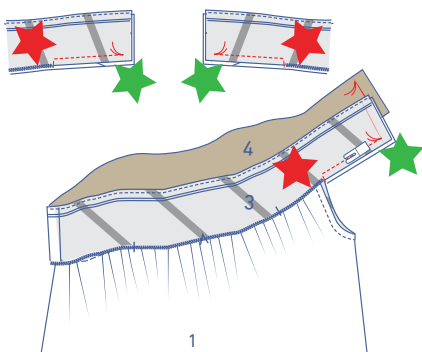

Sew the illustrated ends from the bottom marking thread to the single notch marking the finished armhole.

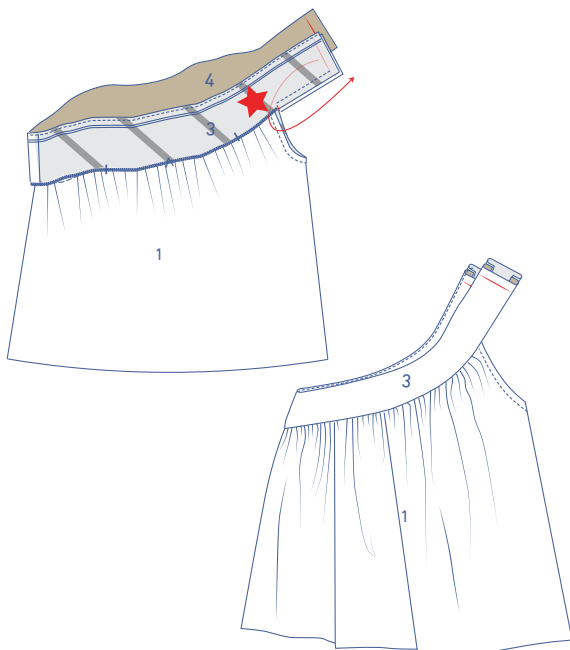

Turn out the trim: push all of the red star trim through the opening at the shoulders onto the wrong side of the garment.

Join each of the trim pieces together. Open up the seam allowances, place right sides together and sew them from marking thread to marking thread. This is a pretty tricky affair because you don't have much wiggle room.

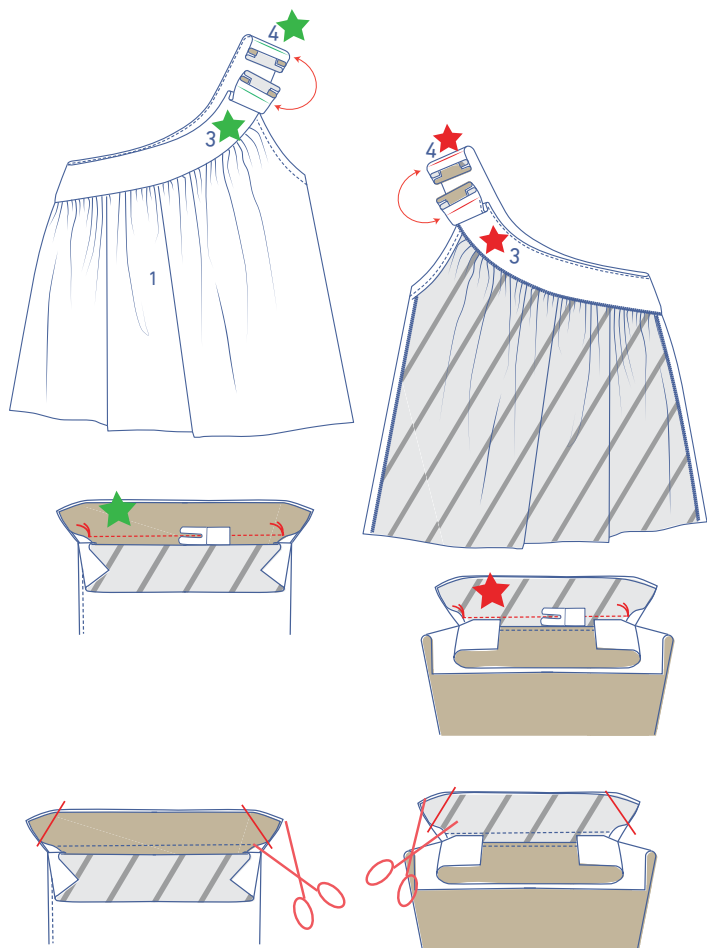

Trim the seam allowance at the tips at an angle to prevent the fabric from bunching and carefully open the seam allowances out.

Open the right way out so that the wrong sides are facing.

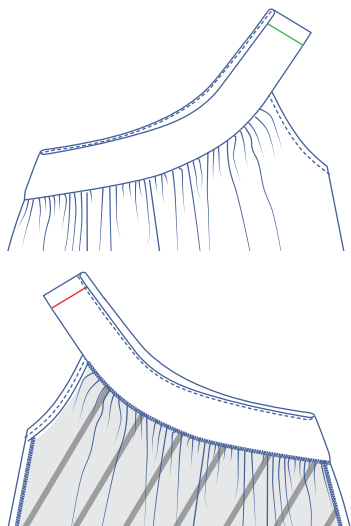

Pin the trim into place and stitch in the ditch.

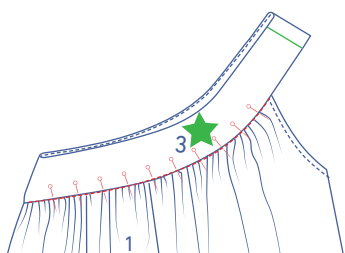

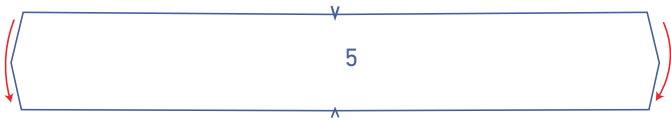

or

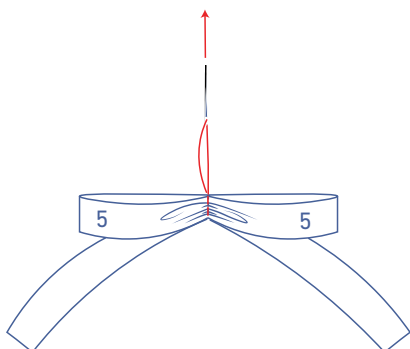
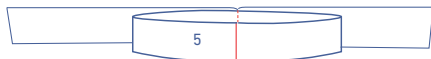

## 4

Fold the short ends of the tie (5) in half with the right sides of the fabric facing.

Stitch the indicated edges. Leave a small opening so that you can turn it the right way out again.

Turn the right way out so that the wrong sides are facing. Sew the opening closed or topstitch right next to the edge.

Press the long edges of the tie in half to create a fold line. It doesn't necessarily need to be folded neatly in half. In that case, the ties will be asymmetrical.

Stitch vertically at 25 cm (or further if you fancy a dramatic bow) from the fold line.

Push the 'bow' flat so that the fold line is aligned with the seam.

Thread a double strand of thread around the centre of the bow and pull a little to crease the fabric at the centre of the bow. Make a small knot with the thread to secure the fabric into place.



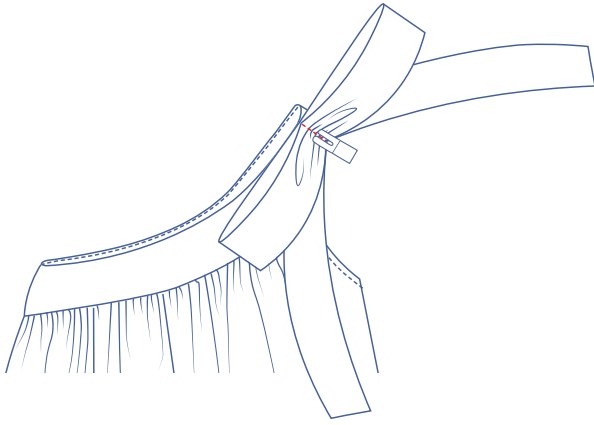

Hand sew or stitch the bow into place on the shoulder seam.

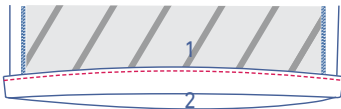
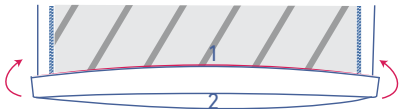
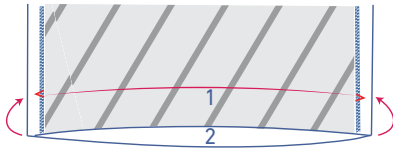
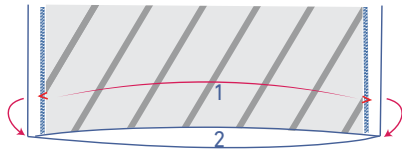
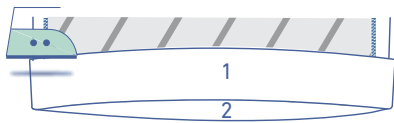

---

## 5

Press the hem allowance up at the V notches and then open back out.

Match the raw edge to the pressed fold line and fold up again.

Sew into place next to the edge.