

Tilly by Fibre ⚡ood



Tilly by Fibre ood



4 - 32

The elegant Tilly has beautiful details that no fashionista could possibly miss. The top has a subtle officer collar, tapered, somewhat higher button wrist trim, and charming patch chest pockets. However, the real gems are Tilly's gorgeous sleeve hem pleats. Make them recessed or turn them into twin 'fins' on the outside; either way, they'll create a pop of volume.

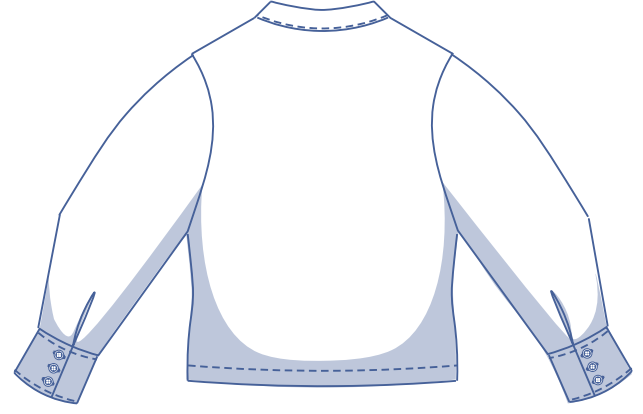
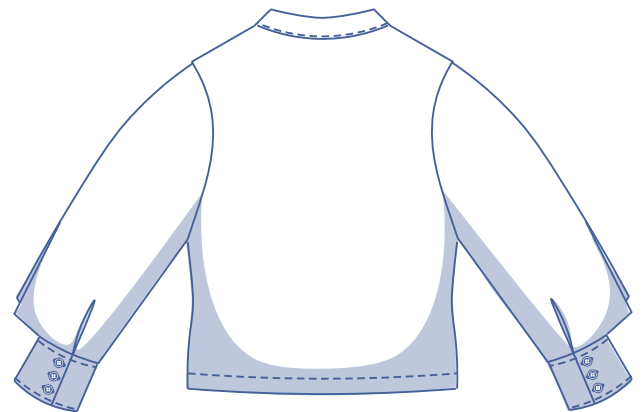

size chart (in cm)

size	4	6	8	10	12	14	16	18	20	22	24	26	28	30	32
body height	160	164	166	167	168	169	170	171	172	172	172	172	172	172	172
B (bust)	76	80	84	88	92	96	100	104	110	116	122	128	134	140	146
H (hips)	86	90	94	97	100	103	106	109	115	120	125	130	135	140	145

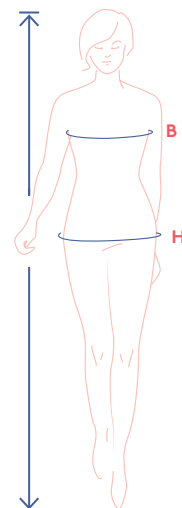

Choose your size based on your **bust measurement**. If your hip measurement is wider than what's listed in the size chart, check the hem circumference in the chart below to see if there's enough room or whether the pattern needs to be altered. It's easy to do. Simply trace the line of the one size instead of the other.

pattern measurements (in cm)

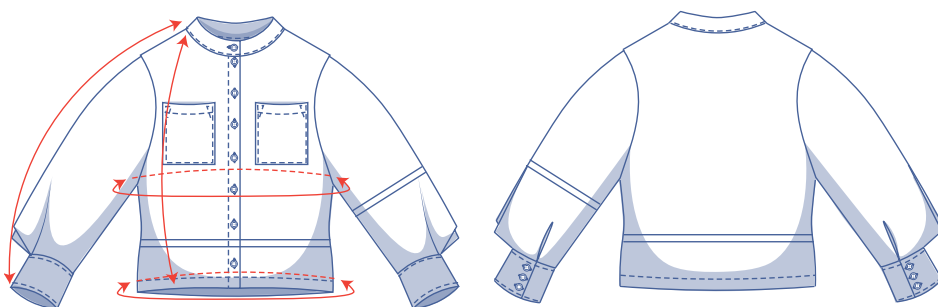

== shorten or lengthen the pattern here

This chart's measurements are the pattern measurements based on the fabric type and serve as a reference. Ease has been added to the width measurements (in addition to the exact body measurements) for a more comfortable fit. Tilly is designed to be **comfy**.

size	4	6	8	10	12	14	16	18	20	22	24	26	28	30	32
length	63.75	64	64.25	64.5	64.75	65	65.25	65.5	66	66.5	67	67.5	68	68.5	69
sleeve length*	68.75	69.5	70	70.5	71	71.75	72.25	72.75	75.25	76	76.5	77.25	77.75	78.5	79
bust	88.75	93	97	101	105	109	113	117	123.25	129.25	135.25	141.25	147.25	153.25	159.25
hem circumference	93.25	97.25	101.25	104.25	107.25	110.25	113.25	116.25	121.25	126.25	131.25	136.25	141.25	146.25	151.25

* Including shoulder length and cuff.

Compare the stated lengths to the measured or desired lengths. **Lengthen** or **shorten** the top and/or the sleeves by cutting the pattern pieces at the indicated double lines. Then either increase the distance between the cut pieces by the desired amount (to lengthen), or overlap the pieces (to shorten). Make sure that the CF and CB lines and the side seams are always straight.



IMPORTANT

Adjust the amount of fabric to be used based on these alterations.

notions



- Thread
- Iron-on interfacing: max. 70 cm
- Buttons (Ø 1.5 cm): 14
- Fabric: see table

fabric		4	6	8	10	12	14	16	18	20	22	24	26	28	30	32
fabric width 110 cm	cm	225	230	230	235	250	250	255	255	260	285	290	290	305	310	315
fabric width 140 cm	cm	165	170	170	170	170	170	175	175	175	175	180	180	185	205	205

The corresponding fabric layout can be found on page 6 of these sewing instructions.

fabric advice Tilly works well in all kinds of fabrics, from drapery viscose (crepe), lyocell to somewhat more structured fabrics like poplin, chambray, lace and fine or baby wale corduroy. Whether it's a solid or a colourful print – it's up to you! Woven fabrics work best due to the details.



Proud to be #Sewista

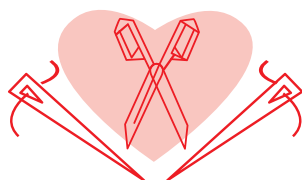

pattern pieces & seam allowances (in cm)

To sew the garment as described in the instructions, draw the illustrated seam allowances around the paper pattern pieces before cutting them out. If you are using a PDF pattern, the pattern can be printed with or without seam allowance. To find out more, watch the [video](#).

- | | |
|------------------------------|-----------------------|
| 1. front: 2x | 5. cuff: 2x |
| 2. back: 1x on fabric fold | 6. sleeve binding: 2x |
| 3. collar: 2x on fabric fold | 7. chest pocket: 2x |
| 4. sleeve: 2x | |

IMPORTANT

The pieces highlighted in light yellow have iron-on interfacing attached to the wrong side.

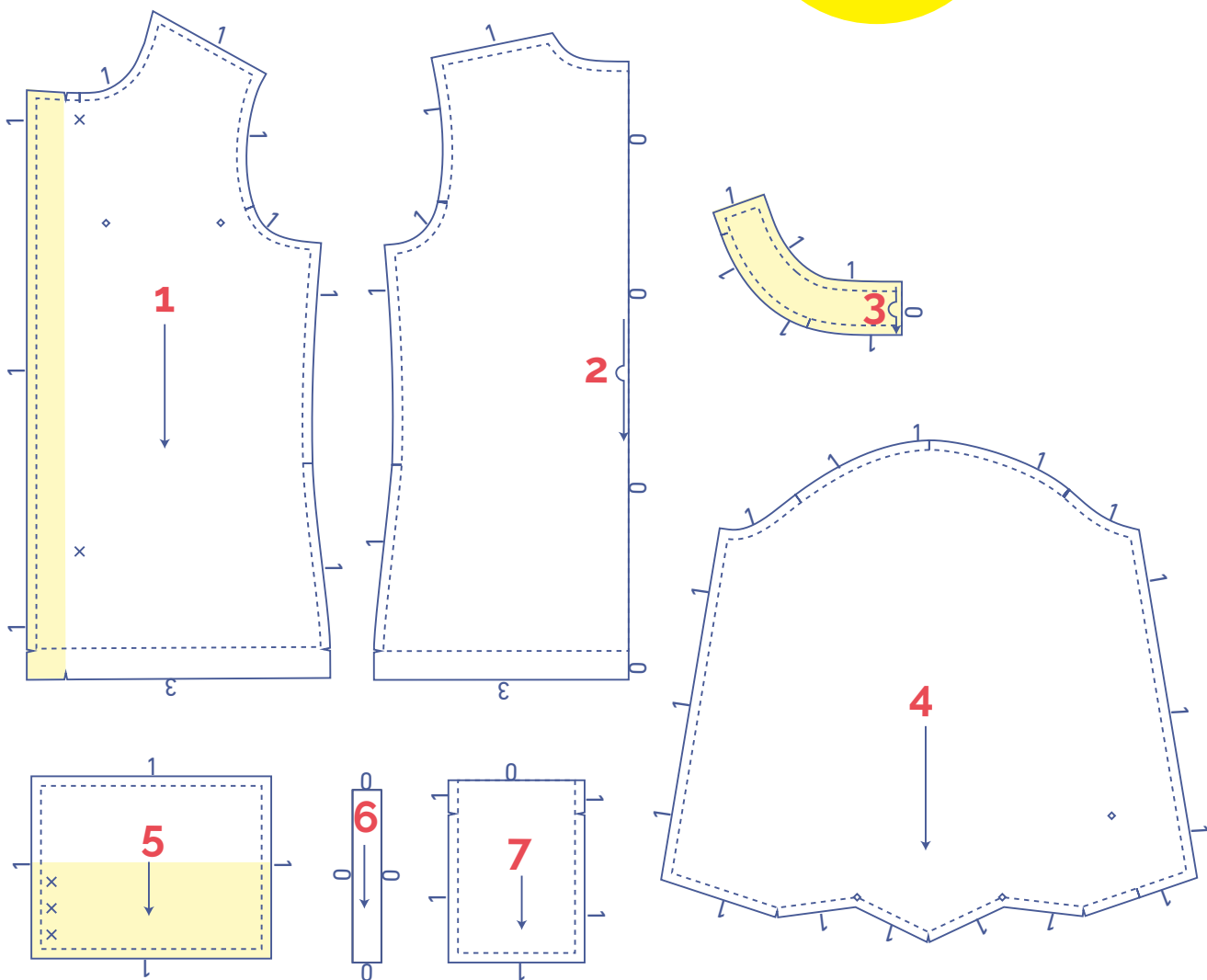

	material type
	fabric
	iron-on interfacing

fabric layout – solid fabrics
fabric width 110 cm

4 - 20

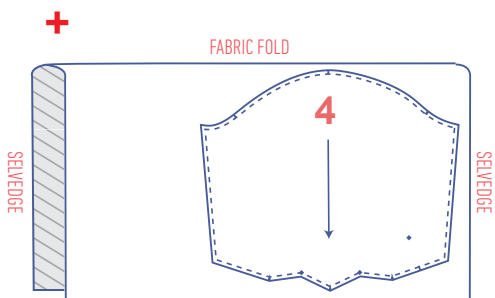
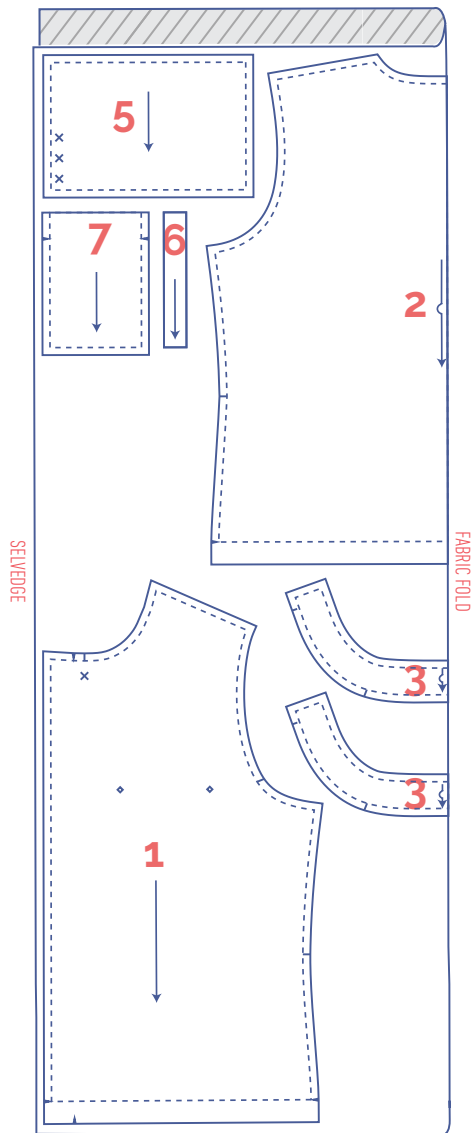

22 - 32

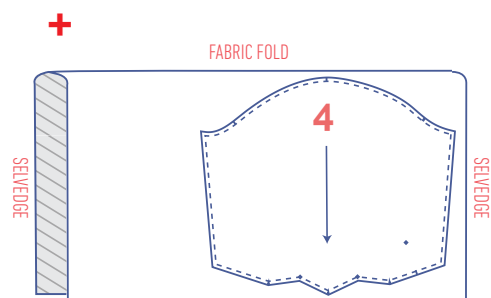
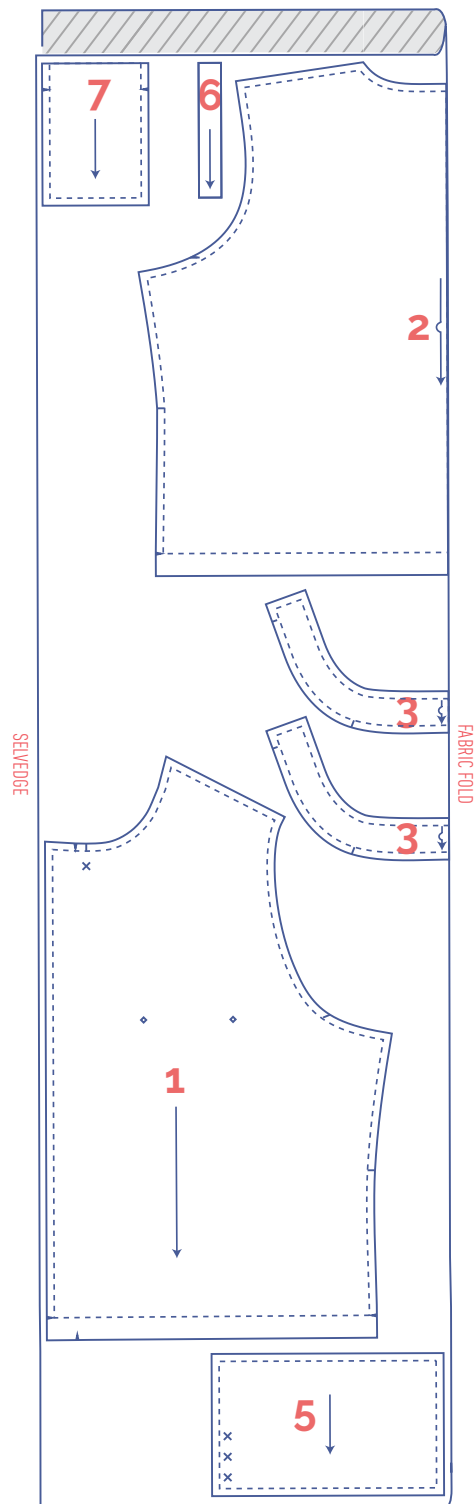

fabric layout – solid fabrics
fabric width 140 cm

4 - 18

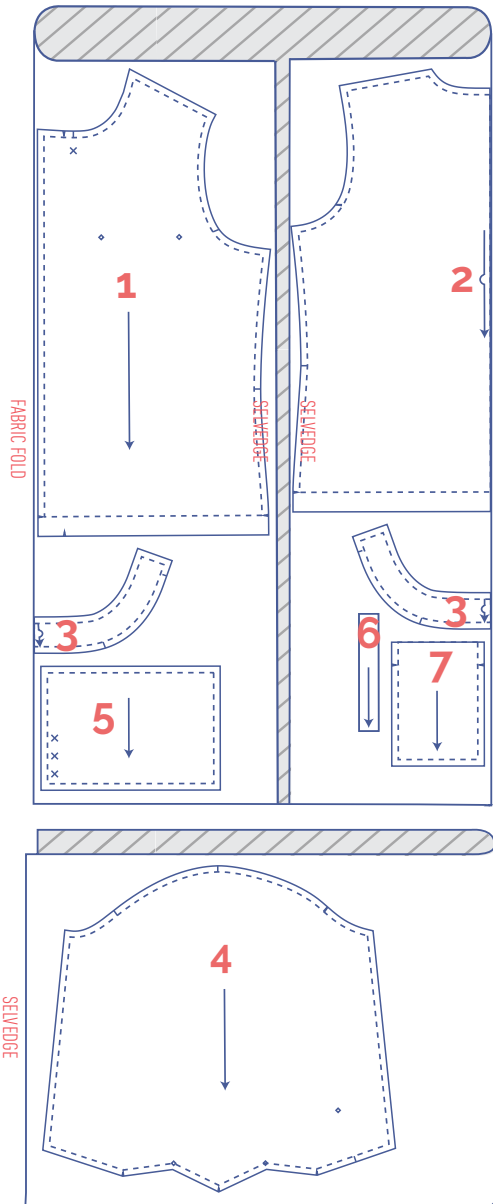

20 - 32

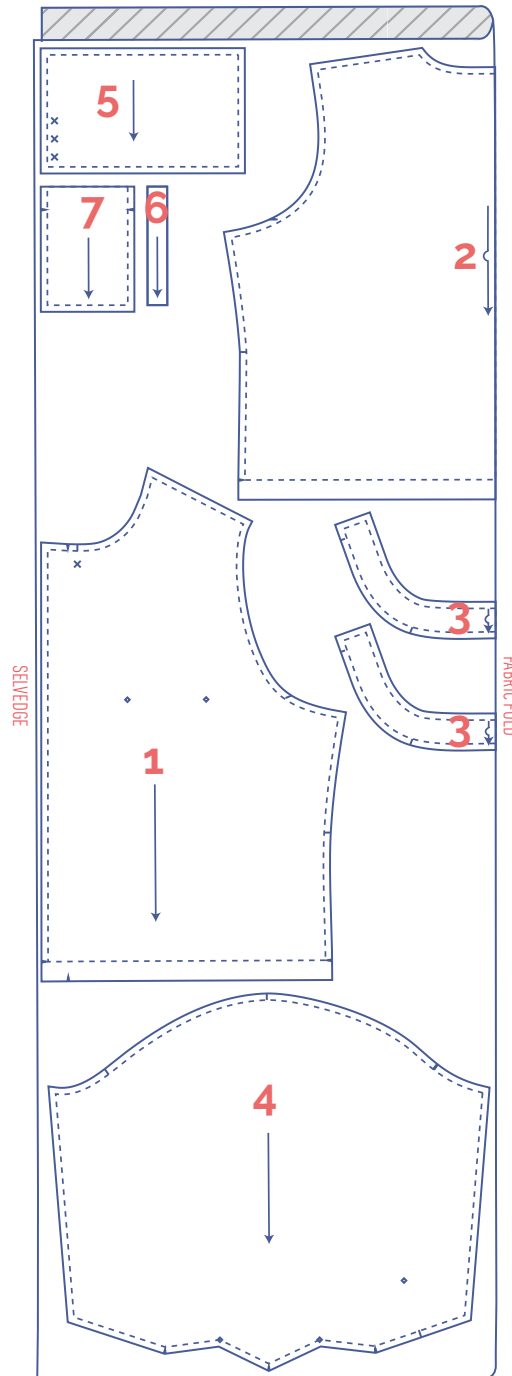

marking pattern pieces

	Notch the pattern paper and fabric at the following points		Mark the following points using marking thread
	single notch		centre point
	double notch		snap/button
V	V notch		

sewing instructions



The method used to finish the seams depends on the fabric used.
The pieces are always sewn together with the right sides of the fabric facing, unless stated otherwise.

F front

B back

RF right front 

LF left front 

CF centre front

CB centre back

 right side

 wrong side

 iron-on interfacing

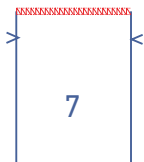
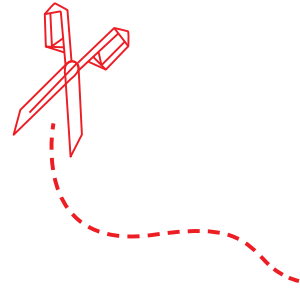

1

Finish the top of the chest pocket (7) with overlock stitching.

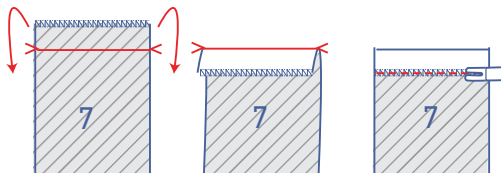

Press over at the V notches and stitch into place.

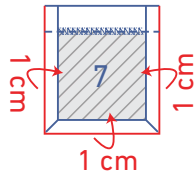

Press the remaining raw edges of the pocket 1 cm towards the wrong side.

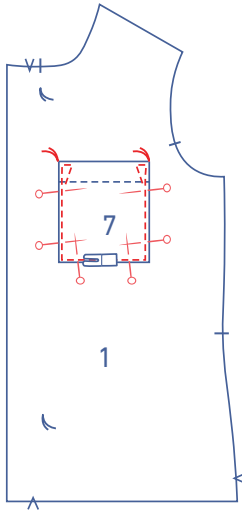

Pin the pocket to the front (1) where indicated. Edgestitch into place. Sew reinforcement triangles at the top on both sides of the pocket.

2

Press the 1 cm seam allowance at the CF towards the wrong side.

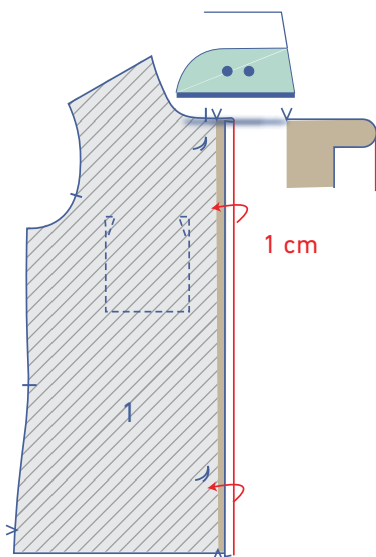

Next, fold over again towards the wrong side at the V notches and press.

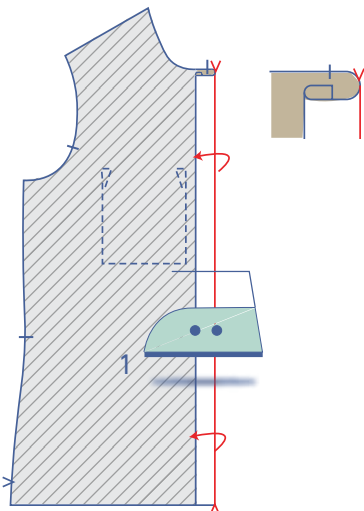

Edgestitch into place.

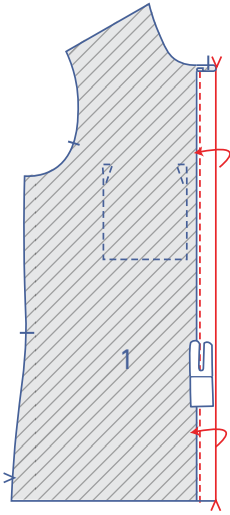

Pin and sew the shoulder seams of the front and back (2).

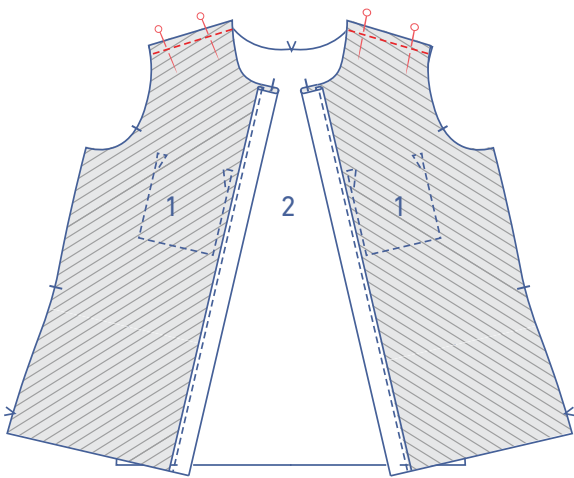

Finish the raw edges together with overlock stitching.

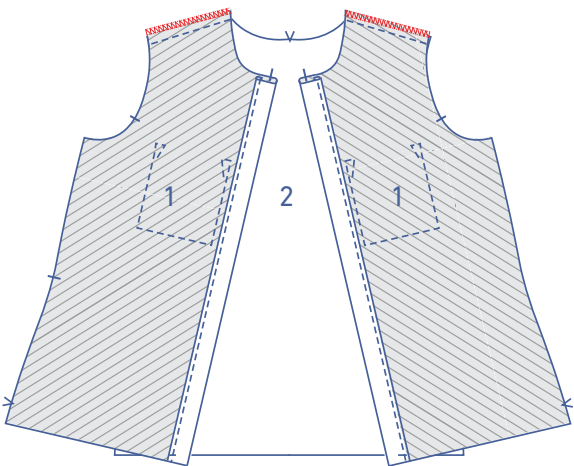

Press the seam allowance towards the front.

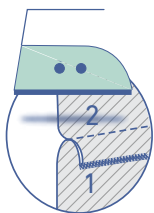

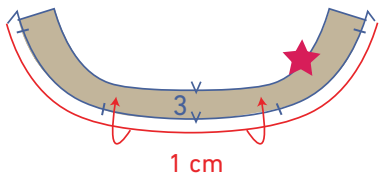

1 cm

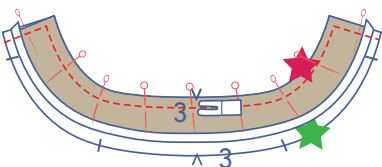
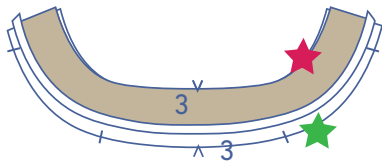
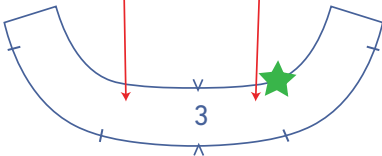
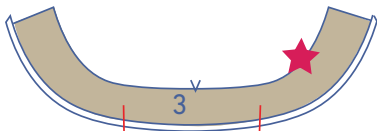
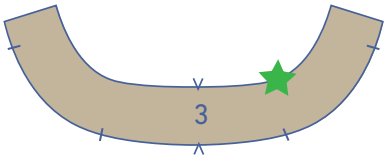
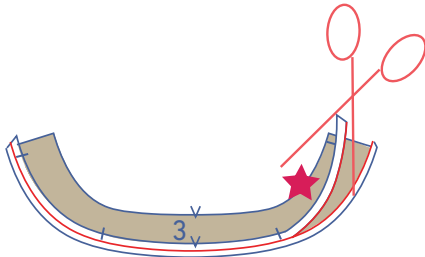
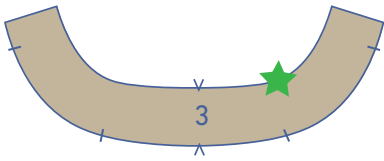

3

Press over the bottom of one of the two collar pieces (3) towards the wrong side by 1 cm. We've marked this collar piece with a red star.

Trim the excess seam allowance with appliqué scissors.

Place the red star collar piece on top of the green star collar piece (= the collar that has not been pressed at the bottom), right sides together.

Pin and sew the contours where indicated.

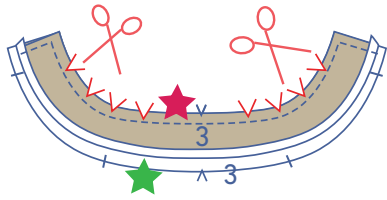

Trim the seam allowances to enable the collar to lie flat when turned out.

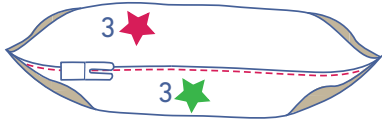

Open the collar back out. Sew the green star collar to the seam allowance underneath right next to the seam. Sew as far as you can.

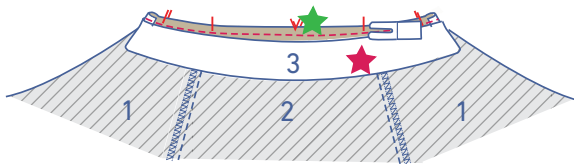
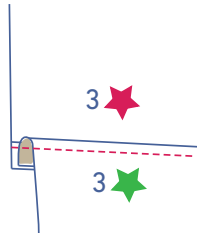

Pin and sew the green star collar to the neckline along the wrong side of the top.

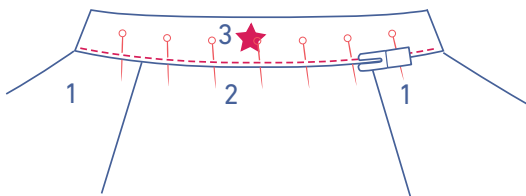

Fold the collar up and place the folded edge of the red star collar directly on top of the previous stitching. Pin and sew into place.

4

Finish the sides of the front and back with overlock stitching.

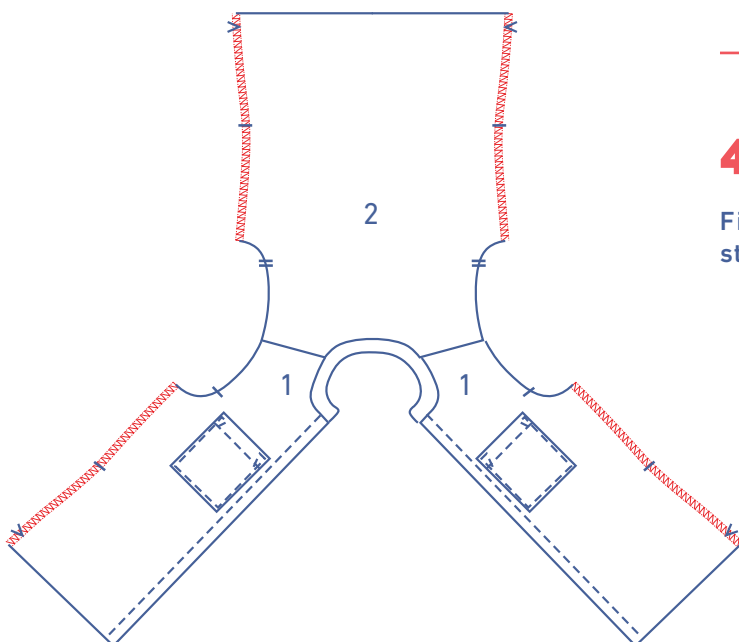



Pin and sew the side seams together.

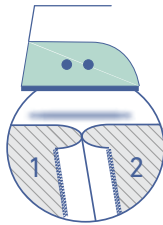

Press the seam allowance open.

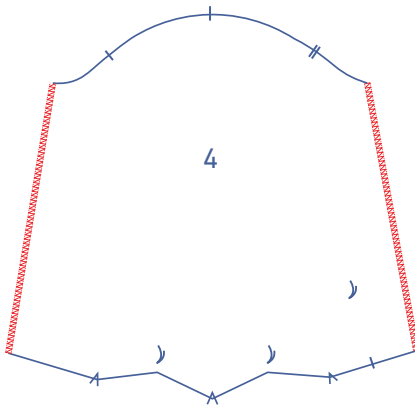

5

Finish the sleeve sides (4) with overlock stitching.

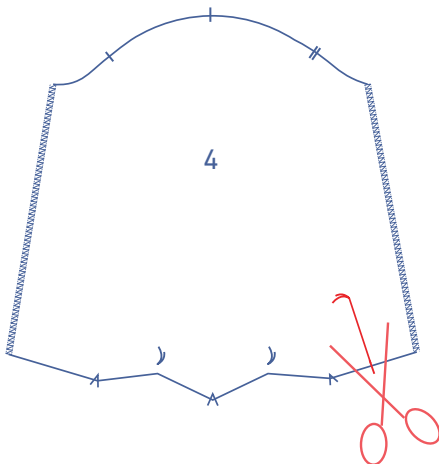

Snip into the sleeve from the notch in the hem up to the marking thread.

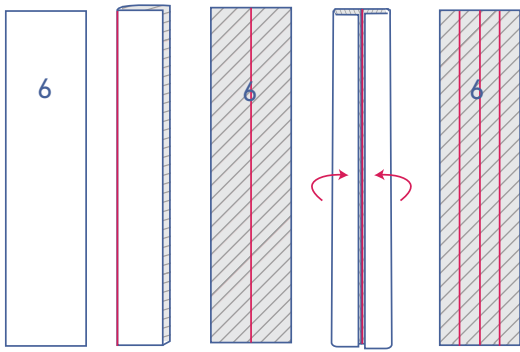

Press the sleeve binding (6) as follows:

- Start by pressing the bias tape in half so that the long ends meet all the way across, creating a fold line down the middle. Open back out.
- Next, press the long ends until the raw edges meet the fold line. Open the bias tape back out.

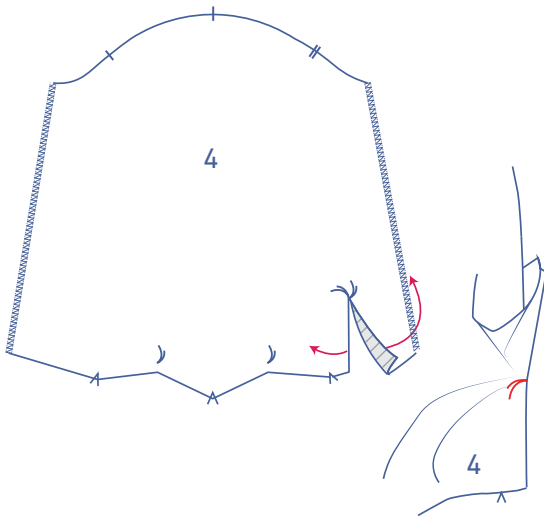

Open the sleeve split so that you end up with a single straight line.

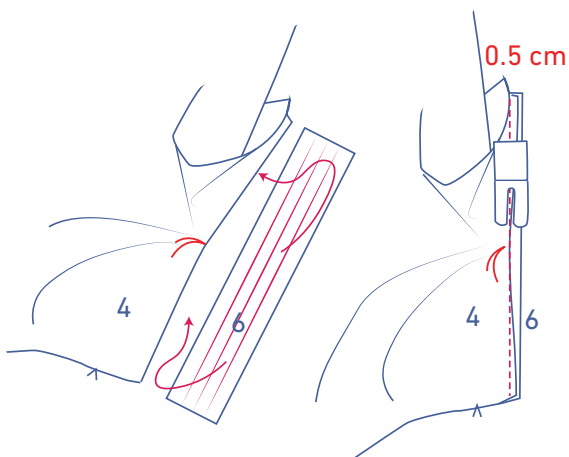

Slide the sleeve binding under the sleeve with the right side facing up. Line up the long ends of the bias tape with the edges of the sleeve splits. At the marking thread, pull the sleeve a little to the side. Sew into place at 0.5 cm. You'll only have sewn a tiny bit of fabric at the marking thread.

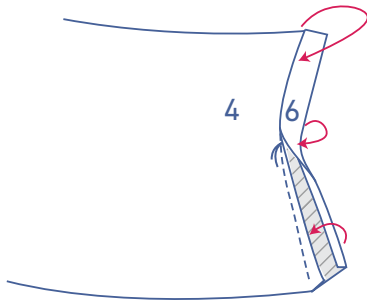

Fold the bias tape onto the right side of the sleeve. Tuck the raw edge under and place the pressed fold line directly over the previous stitching. Edgestitch into place.

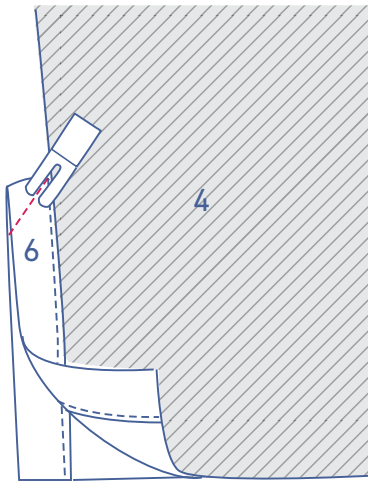
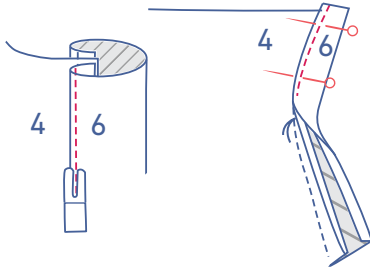

Fold the sleeve in half crosswise with the right sides facing. Sew the top of the bias tape together at an angle.

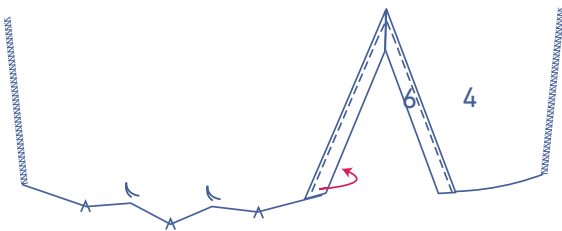

Fold the bias tape at the front of the sleeve (check for the V notches) all the way over to the wrong side of the sleeve and stitch the bias tape into place at presser foot width from the bottom.

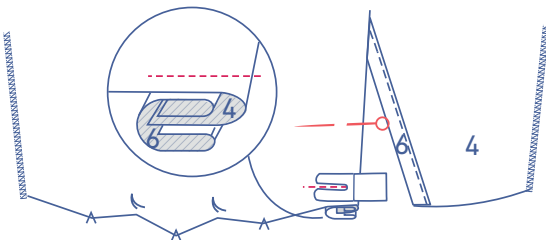

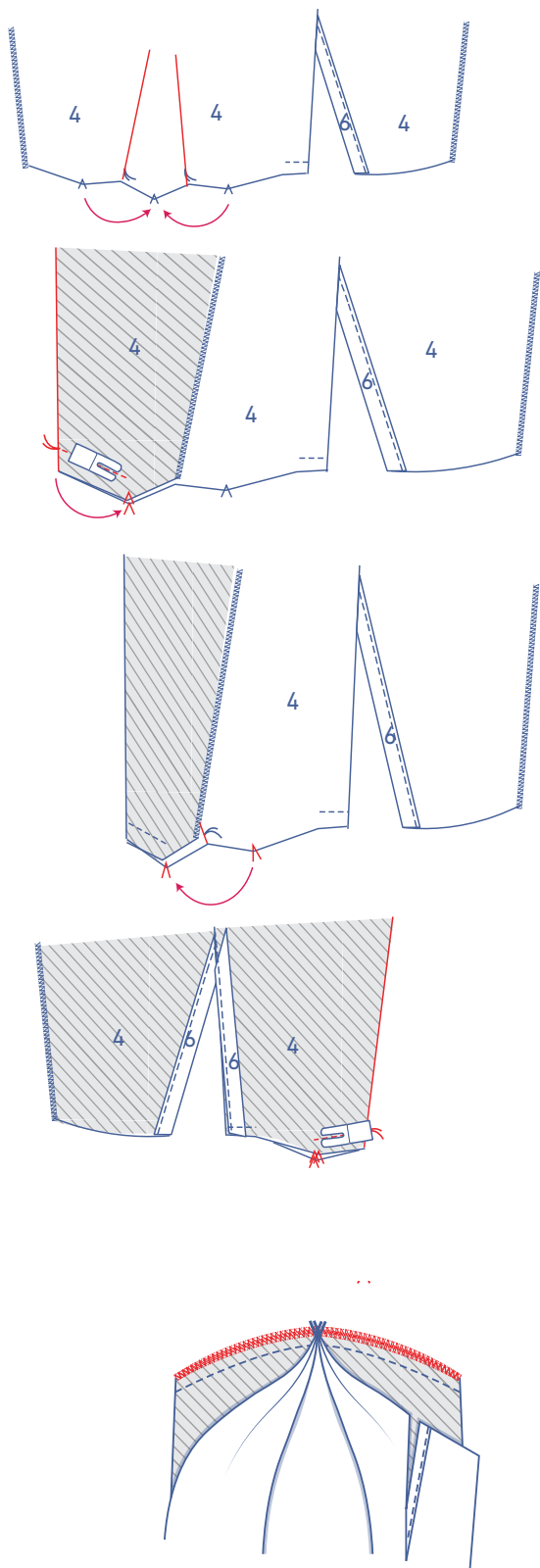

Create the two pleats at the bottom of each sleeve.

Match the V notches at the bottom of the sleeve with the right sides of the fabric facing. Sew towards the V notch from the marking thread. Stop stitching 1 cm above the V notch.

Repeat this step for the second pleat.

Finish the raw edges together with overlock stitching.

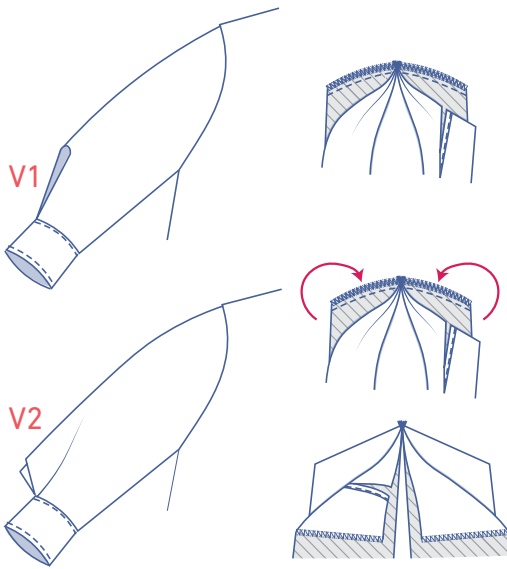

You now have two options. One, the pleat allowance can fold inwards (V1) or two, it can feature on the outside (V2). The look you create will depend on which version you make. The pleat allowance on the inside will create a more streamlined sleeve. Pleat allowance on the outside creates more volume.

V1: Turn the sleeve over so that the right side is facing up and the pleats are neatly on the wrong side of the sleeve.

V2: Push out the pleats out so they are turned out the other way (ie. so the overlocking is hidden)

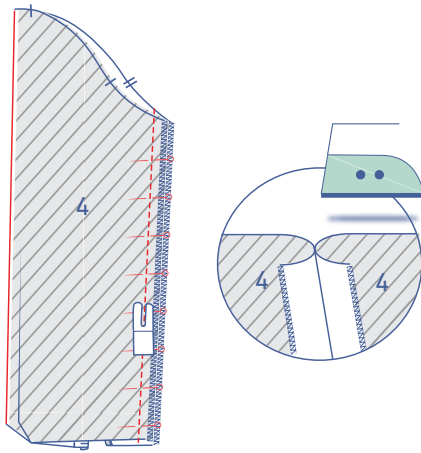

Pin and sew the sleeve sides.

Press the seam allowance open.

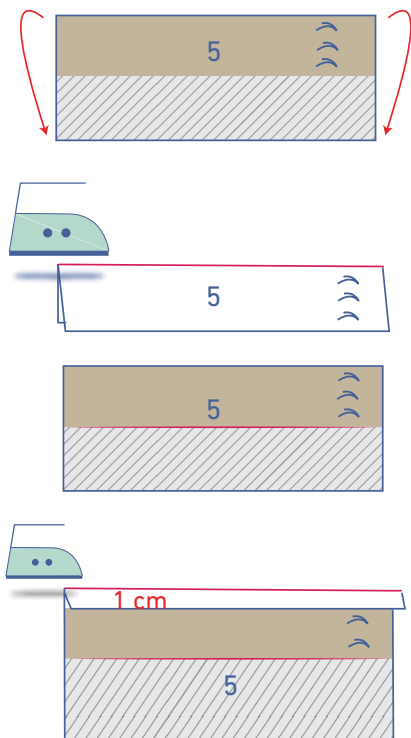

6

Fold the cuff (5) in half with the long ends together and the wrong sides of the fabric facing to create a fold line. Open back out.

Fold and press the long end on the button side towards the wrong side by 1 cm.

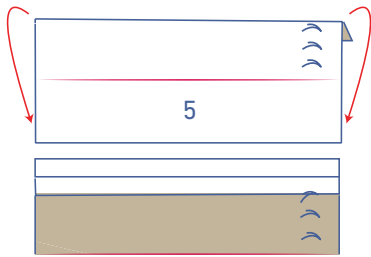

Fold the cuff in half at the pressed fold line with the right sides of the fabric touching.

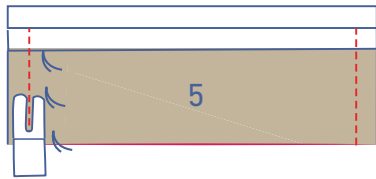

Sew the short ends closed.



Turn the right way out so that the wrong sides are touching.

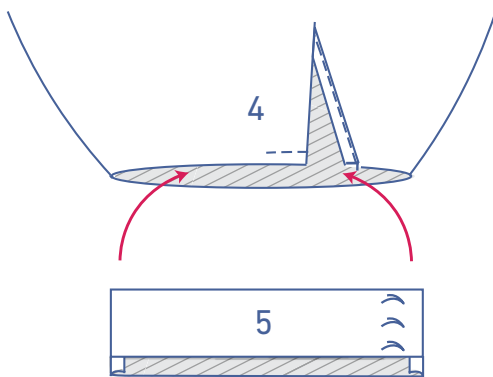

Slide the cuff into the sleeve. Pin the unpressed raw edge of the cuff to the bottom of the sleeve along the inside (= the wrong side) and sew into place.

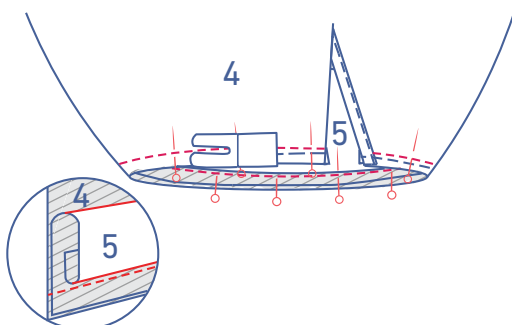

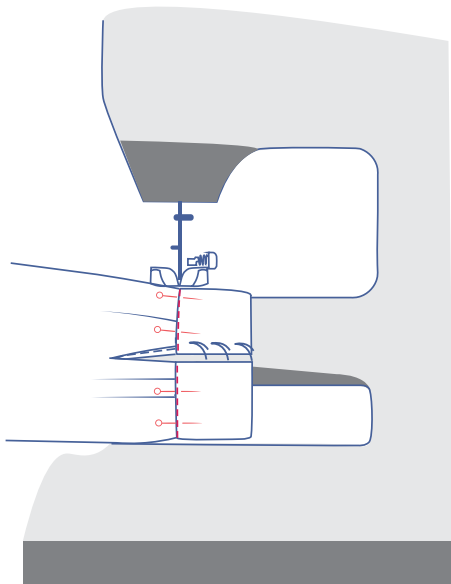

Open the cuff out to the right side of the sleeve. Place the fold line directly over the stitching. Edgestitch into place.

7

Pin the top of the sleeve (= the sleeve cap) to the armhole, matching the notches. The single notch marks the front, while the double notch marks the back. The single notch at the top should be even with the shoulder seam. Distribute the excess fabric between the top notches and sew into place. Be careful not to snag or sew any puckers.

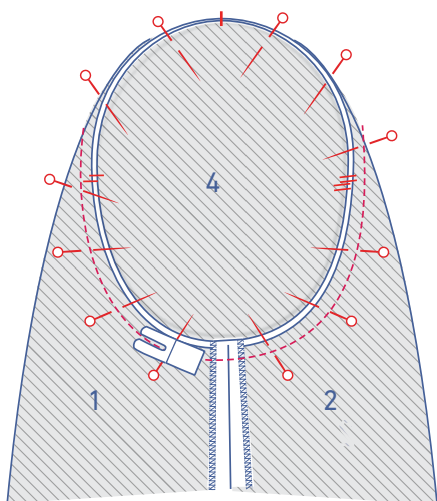

Finish the raw edges together with overlock stitching.

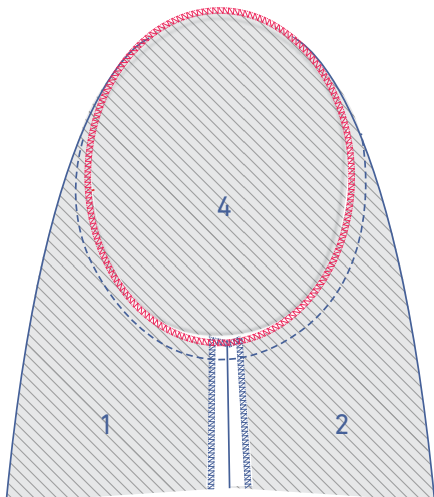

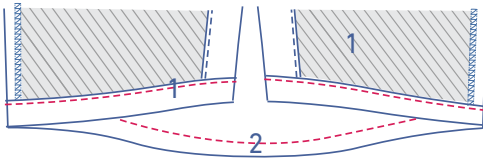
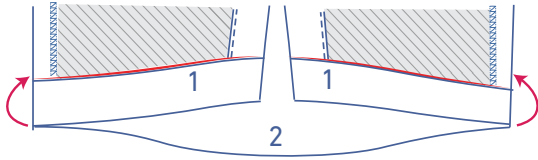
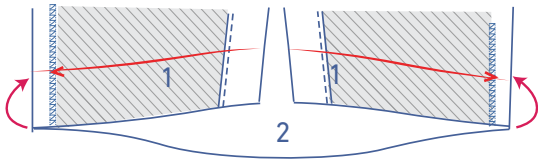
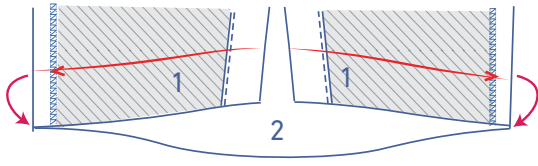
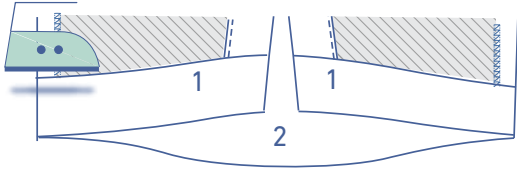

8

Press the hem allowance up at the V notches and then open back out.

Match the raw edge to the pressed fold line and fold up again.

Sew into place next to the edge.

9

Sew the buttons onto the LF. The positions of the top and bottom buttons have been marked on the pattern for you. Divide the distance between them evenly to determine the location of the other buttons.

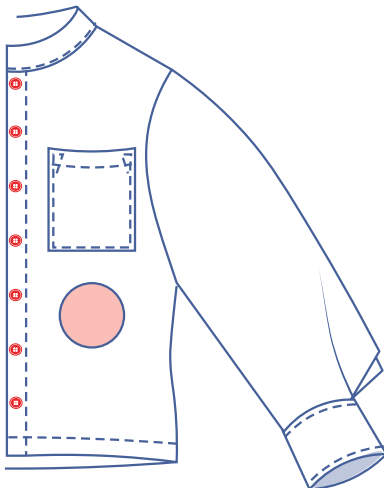

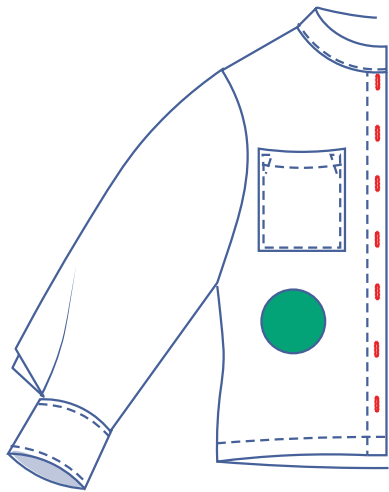

Make vertical buttonholes in the RF based on the location of the buttons.

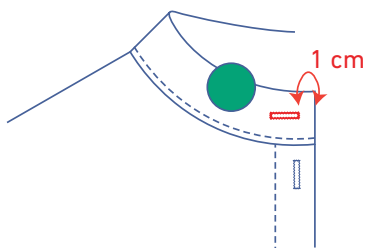

Make a horizontal buttonhole on the right side of the collar halfway up at 1 cm from the finished edge.

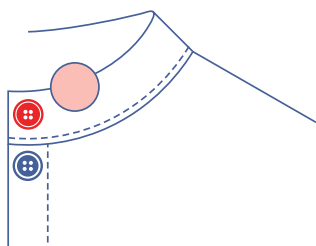

Sew a button to match on the collar on the left side.

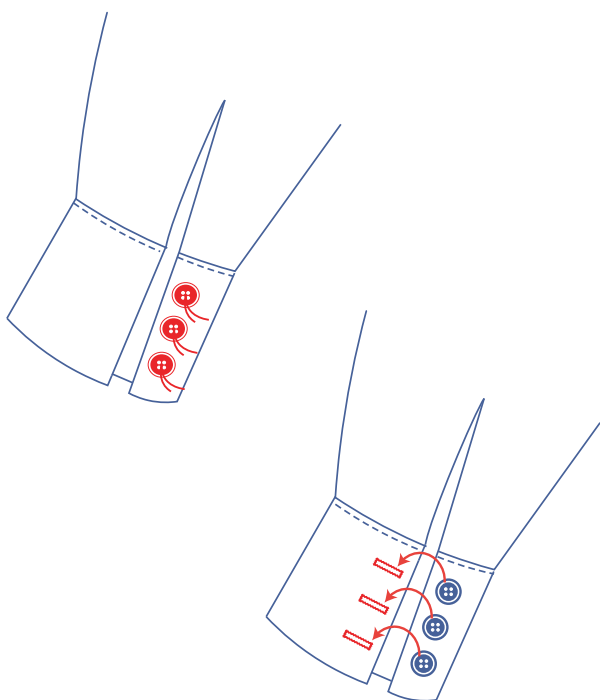

Sew the buttons on the cuff where indicated.

Make horizontal buttonholes based on the button locations.